

Unit Information
 120V - 60Hz - 4.8 Amps
 1 Year Warranty

WARING
COMMERCIAL

Juice Extractor

5001C
 plastic bowl & cover

6001C
 stainless Steel bowl & cover



015402
 Name Plate

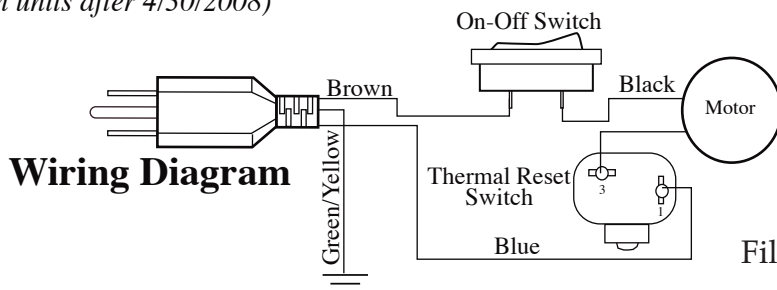
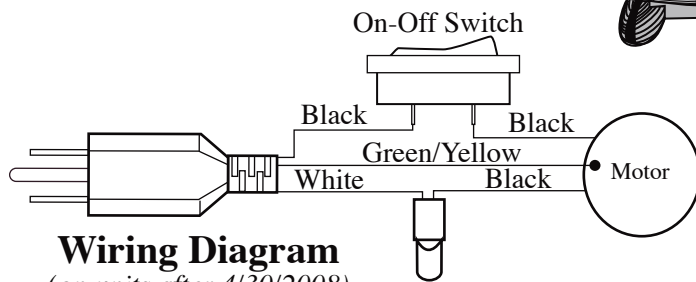
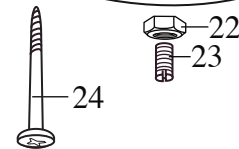
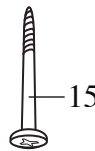
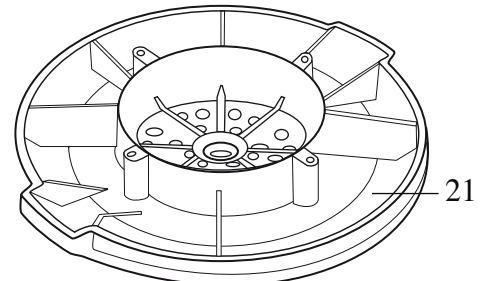
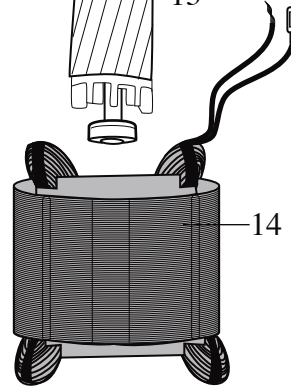
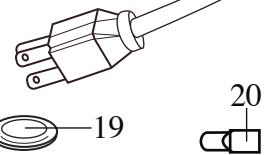
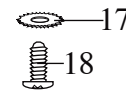
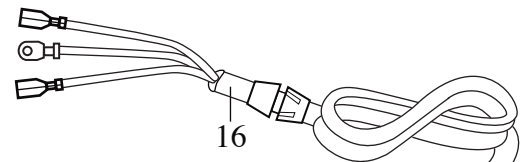
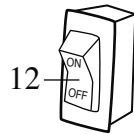
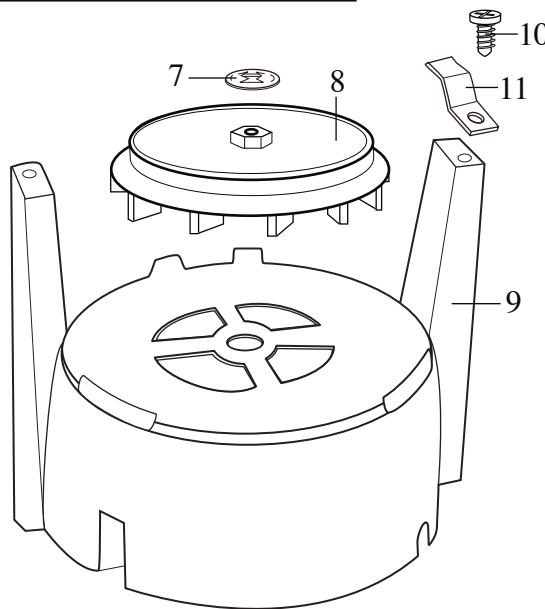
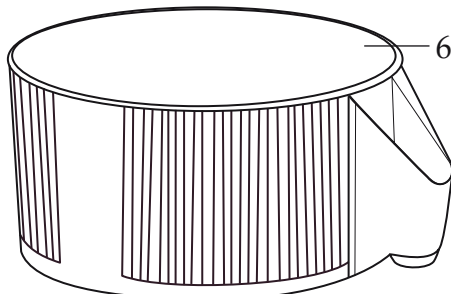
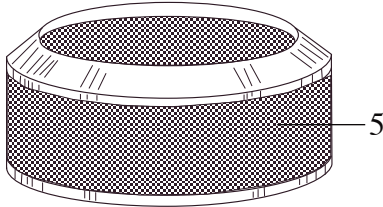
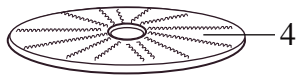
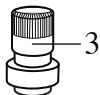
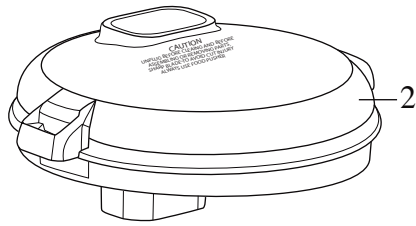

501289
 Filters (package of 200)

Catalog	Model
5001C	31JE26
6001C	31JE27

Waring Factory Service Center
314 Ella T. Grasso Ave.
Torrington, CT 06790
Tele. 1-800-269-6640
Fax 860-496-9017
www.waringcommercialproducts.com

Illustration #	Part #	Description
1	016126	Black Pusher
2	015170	Plastic Cover
	028066	Stainless Steel Cover <i>(changed after 3/27/2009)</i>
3	026093	Clutch <i>(changed after 3/12/2002)</i>
4	015180	Shredder Plate (blade)
5	015174	Strainer Basket
6	015168	Plastic Bowl
	015205	Stainless Steel Bowl
7	015167	Speed Nut
8	015166-01	Impeller <i>(changed after 1/6/2003)</i>
9	028739-01	White Top Housing <i>(on units after 10/21/2011)</i>
	015406	White Upper Housing
10	017887	Screw (2 required)
11	015178	Cover Lock (2 required)
12	017245	Rocker Switch
13	026572	Rotor Assembly <i>(on units after 6/9/2003)</i>
	501235	Rotor Assembly (with 015158 - Ball Bearing)
14	029029	Stator <i>(on units after 4/30/2008)</i>
	502918	Stator <i>(Obsolete on units after 7/9/2003)</i>
	026954	Stator <i>(on units after 6/9/2003 026570 with terminal)</i>
	015176	Stator
15	015177	Screw (2 required)
16	501316	Cord Set
17	015337	Ground Washer
18	002436	Ground Screw
19	015185	Support Disk (2 required)
20	012409	Crimp Connector
21	015186-01-X	Bottom Housing <i>(on units after 4/30/2008)</i>
	015186-01-A	Bottom Housing <i>(on units after 10/5/2006)</i>
	015186-01	Bottom Housing
22	015188	Hex Nut
23	015187	Set Screw
24	015177	Screw (4 required)
25	016129	Black Foot Ring

Parts No Longer Used *(on units before 6/5/2008)*



015183 - Reset Switch



015184 - Hex Nut