



# SERVER

INTELLIGENT BY DESIGN™

## Server Express™

Used with pouches up to  
1½ gallons with 16mm fitments.

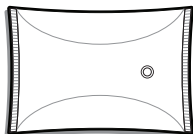

### MODELS:

SE  
SE-SS  
SS-1SE  
SS-2SE  
SE-2  
SE-2DI  
SE-3  
SE-3DI  
SE-4  
SE-4DI  
SE-5  
SE-5DI  
SE-6

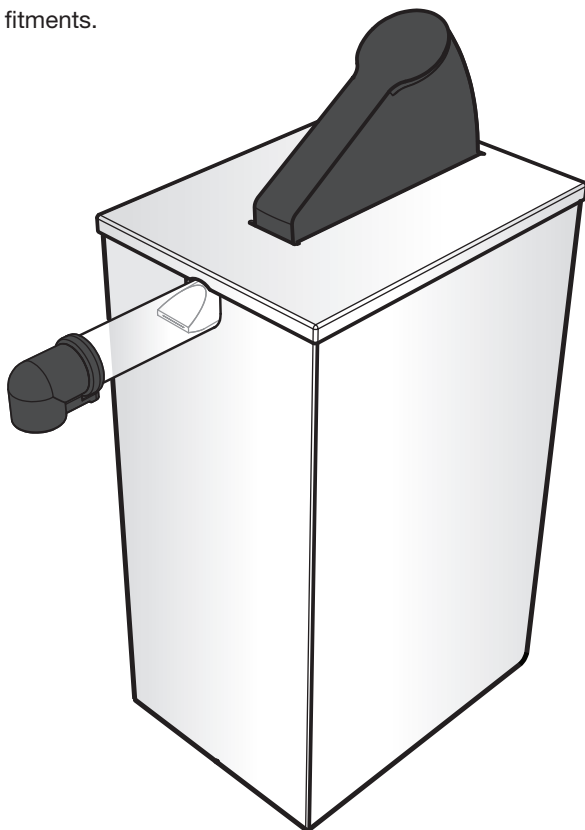

## ***Thank You***

...for purchasing our Server Express™ Pouched  
Condiment Dispenser. This portion controlled unit is  
sealed and sanitary, achieves excellent evacuation and  
has only a few parts for easy clean-up.

SIMPLIFY CONDIMENT MANAGEMENT — GO POUCHED

# SERVER EXPRESS™ MODELS

Your model may vary.  
See pages 2–4.  
Examples include:

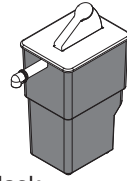

**SE  
07000**  
Rectangular Black

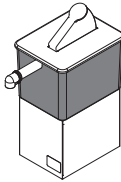

**SS-1SE  
67760**  
Rectangular Single Stand

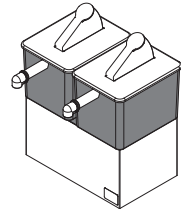

**SS-2SE  
07300**  
Twin Stand

## PARTS

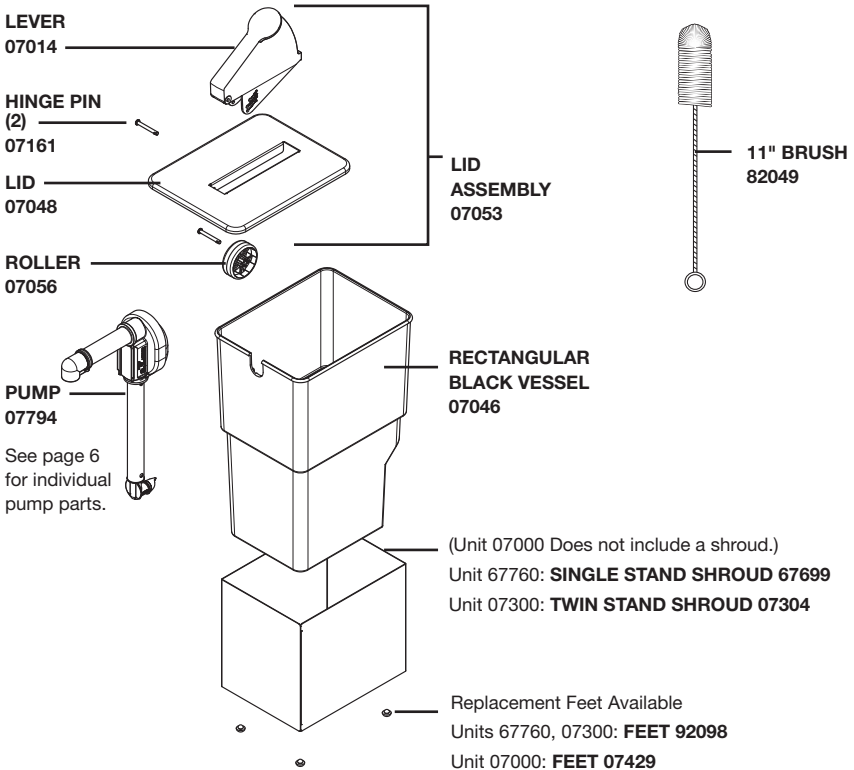

# SERVER EXPRESS™ MODEL

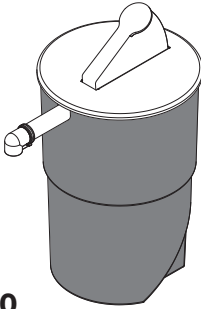

**SE  
07010**  
Round Black

## PARTS

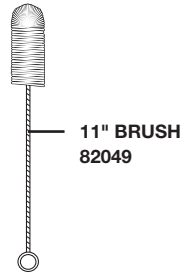
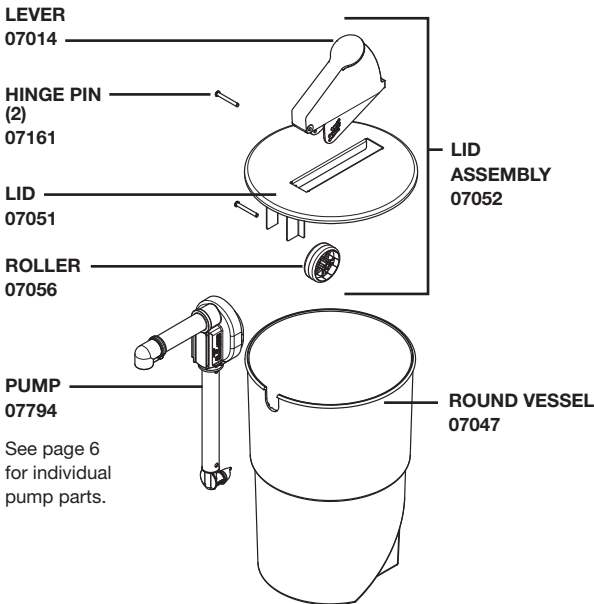

See page 6  
for individual  
pump parts.

# SERVER EXPRESS™ MODELS

**SE-SS**  
**07125**  
Single

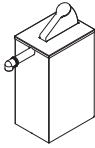

**SE-SS**  
**07020**  
Single Drop-In

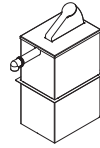

**SE-2**  
**07140**  
Twin

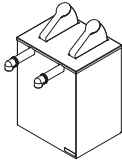

**SE-2DI**  
**07160**  
Twin Drop-In

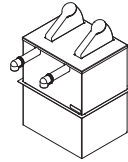

**SE-3**  
**07040**  
Triple

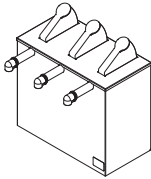

**SE-3DI**  
**07050**  
Triple Drop-In

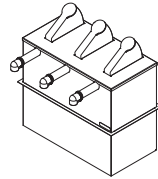

**SE-4**  
**07200**  
Quadruple

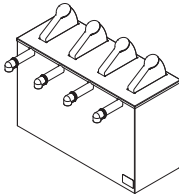

**SE-4DI**  
**07210**  
Quadruple Drop-In

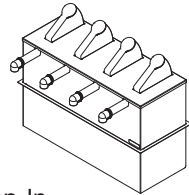

**SE-5**  
**07060**  
Quintuple

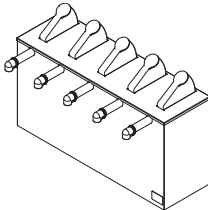

**SE-5DI**  
**07070**  
Quintuple Drop-In

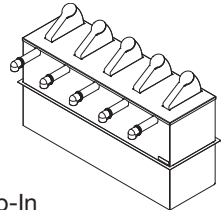

**SE-6**  
**07080**  
Sextuple

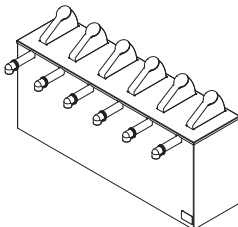

# PARTS

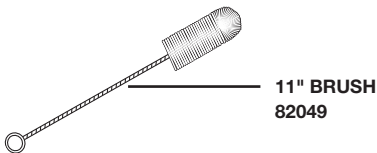
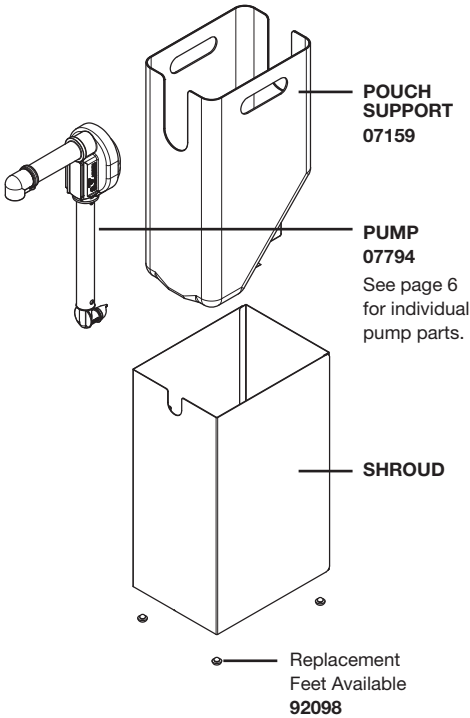
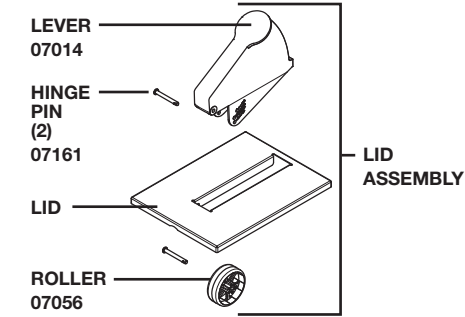

MODEL(S)	LID	LID ASSEMBLY
07125, 07020	07055	07057
07140, 07160	07341	07342
07040, 07050	07079	07083
07200, 07210	07185	07186
07060, 07070	07104	07105
07080	07114	07115

MODEL	REPLACEMENT SHROUD
07125	07345
07020	07327
07140	07343
07160	07344
07040	07328
07050	07329
07200	07331
07210	07332
07060	07333
07070	07334
07080	07109

# SAFETY



According to food and safety regulations, most foods must be stored and/or served at certain temperatures or they could become hazardous. Check with local food and safety regulators for specific guidelines. Server Products, Inc. cannot be responsible for the serving of potentially hazardous product.

## IMPORTANT

**Clean, rinse, sanitize, and dry parts daily or regularly to comply with local sanitization requirements.**



NSF International lists this pump as: "Not acceptable for dispensing potentially hazardous foods."

**ADA**  
compliant

# DROP-IN UNITS

Drop-in units can be used either on a countertop surface or can be dropped into an opening in a countertop.

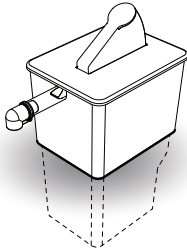

MODEL NUMBER	RECOMMENDED COUNTERTOP OPENING SIZE
07000, 07020	6 3/8" x 8 1/2"
07010	8 1/2" diameter
07160	11" x 8 1/2"
07050	16 3/8" x 8 1/2"
07210	21 13/16" x 8 1/2"
07070	27 3/16" x 8 1/2"

# PUMP MODEL 07794

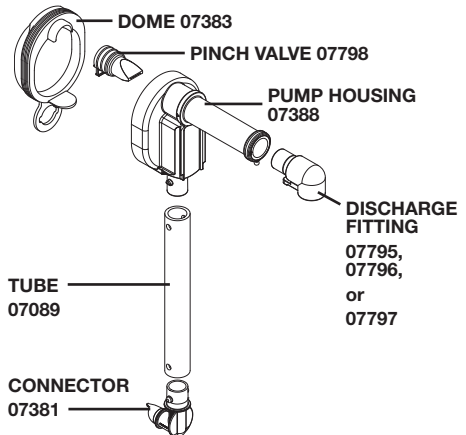
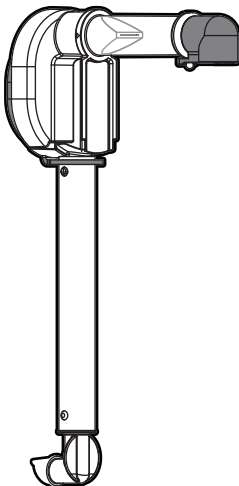

# PUMP ASSEMBLY

WASH ALL PARTS PROPERLY BEFORE USE. See page 11.

## 1 INSERT PINCH VALVE

into pump housing.

*TIP: Squeeze the pinch valve open before installation to ensure it isn't stuck shut.*

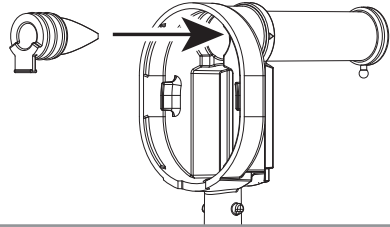

## 2 INSTALL DOME

Press dome into housing fully. Ensure valve flap covers bottom opening.

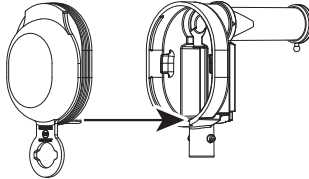

Wrap loop around lower opening to secure dome.

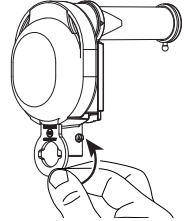

## 3 INSTALL TUBE

Lubricate with a small amount of clean water. Rotate and position until both pegs on housing fit into holes on tube.

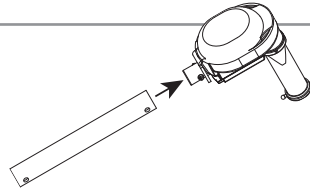

## 4 INSERT CONNECTOR

Lubricate with a small amount of clean water. Rotate and position until both pegs on connector fit into holes on tube. Connector must point away from end of discharge tube.

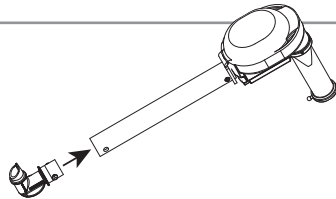

## 5 SELECT DISCHARGE FITTING

**CONSISTENCY OF WHAT YOU DISPENSE**

**SUGGESTED FITTING SIZE**

THIN (hot sauce) ..... SMALL  
 THICK (ketchup or mustard)..... MEDIUM  
 THICKER (relish or tartar sauce)..... LARGE

Fittings are marked small, medium or large on bottom.

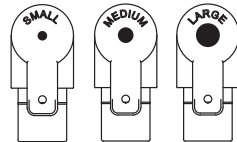

## 6 INSERT DISCHARGE FITTING

into pump housing discharge tube. Place loop of fitting around peg on end of discharge tube to secure.

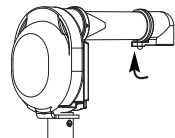
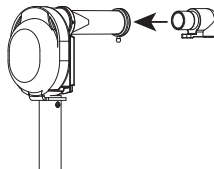

# SETUP



**PRACTICE SAFETY.**  
**WASH ALL PARTS PROPERLY BEFORE USE.** See page 11.

## 1 ATTACH POUCH TO PUMP

Firmly press piercing connector into center of pouch fitment.  
An audible click indicates a secure connection.

*TIP: Prime the pump. Push the dome to draw food up towards the discharge tube.*

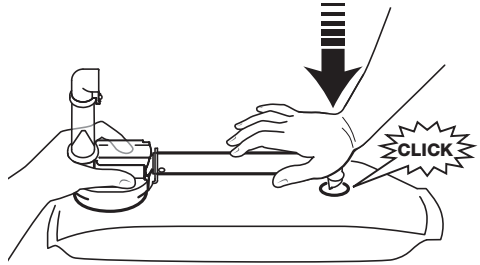

## 2 INSTALL PUMP

Slide pouch and pump into pouch support within shroud.  
Align pump guides into slots in shroud.

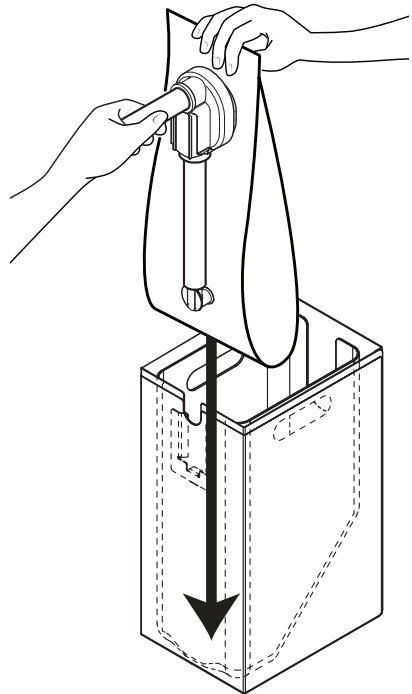



**3 PLACE LID ON TOP**

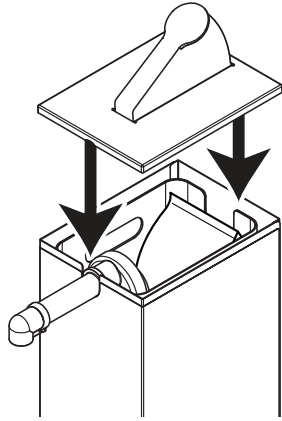

**4 PRIME PUMP**

Press lever several times until you see product in discharge tube.

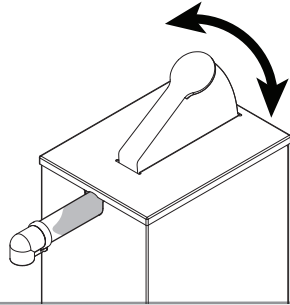

## PORTION CONTROL

**THE LID IS SET TO DELIVER 1 OZ PORTIONS.**

If lid reassembly is needed,  
or to specify a different portion size:

One hinge pin attaches lever to lid.

Second hinge pin attaches roller to lever.  
(Controls portion dispensed.)

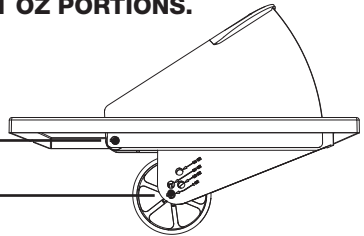

Install hinge pin through center  
roller hole and desired portion  
hole on lever.

Pin snaps into place.

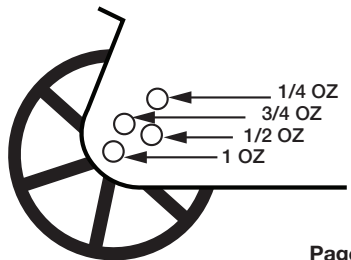
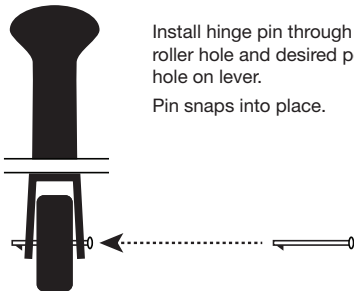

# TAKE-DOWN & DISASSEMBLY

**1 REMOVE LID**

**2 REMOVE PUMP & POUCH**

**3 DETACH PUMP FROM POUCH**

**4 FLUSH & RINSE PUMP**

Place lower end of pump into container of hot water. Pump until all remaining product is expelled and only water flows from discharge tube.

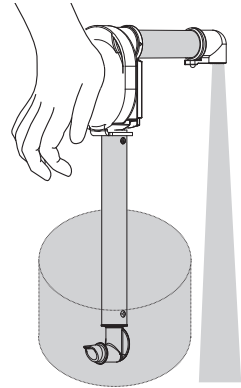

**5 DISASSEMBLE**

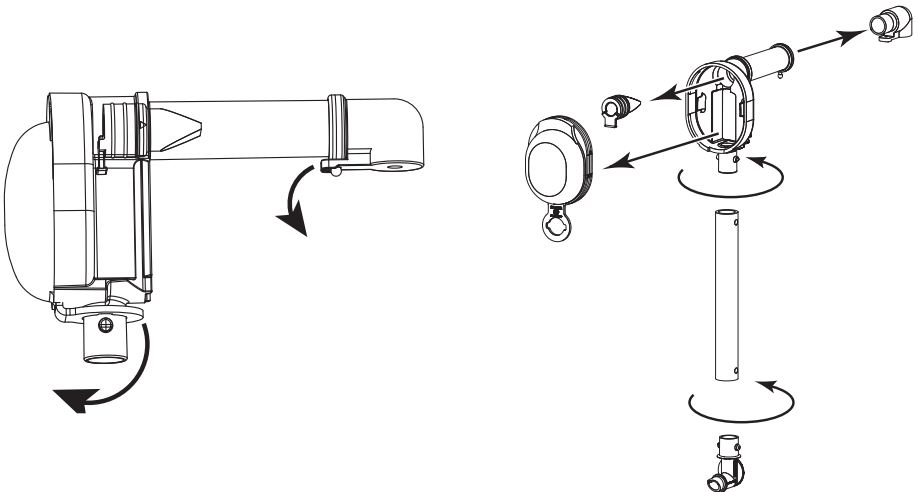

# CLEANING

## 1 CLEAN

After disassembling, clean all washable parts with soap and hot water.

## 2 RINSE

fully with clear water.

## 3 SANITIZE

all parts according to local sanitization requirements. All parts in contact with food must be sanitized.

## 4 AIR DRY

all parts fully.



## YES!

### Use dishwashing soap and hot water

- External surfaces may be wiped clean with a clean damp cloth.
- Glass and surface cleaners approved for use in food contact areas may be used.
- Do not use abrasive, caustic or ammonia based cleansers.
- Do not use metal scrapers or cleaning pads that could scratch surfaces.

# CARE OF STAINLESS STEEL

This unit is constructed with stainless steel— one of the best materials for food serving and storage.

If you notice corrosion beginning on any stainless steel surface, you may need to change the cleansing agent, sanitizing agent, or the cleaning procedures you are using.

- A mildly abrasive nylon or brass brush may be used to remove any stubborn food or mineral deposits on interior surfaces of unit.
- Fully rinsing and drying all parts can help prevent corrosion. Elements and minerals in tap water can accumulate on stainless steel parts and create corrosion.
- Do not use products containing acids, alkalines, chlorine, or salt. These agents can corrode stainless steel.

# TROUBLESHOOTING

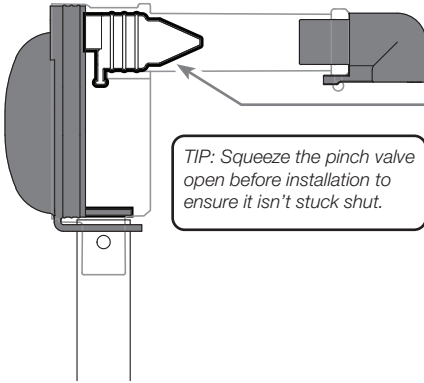

## DIFFICULT TO ATTACH PARTS?

- Wet parts with clean water to help fit.

## PRODUCT DOESN'T PUMP?

- Ensure pinch valve is inserted in housing.
- Ensure connector is snapped fully in place to fitment in pouch.
- Ensure pump is properly attached to pouch.
- Clean pump thoroughly.
- Ensure pump is properly installed into retaining slots inside front wall of shroud.

## DOMES POPS OFF?

- Clean thoroughly. Food residue could prevent a tight seal between dome and housing.
- Ensure dome edges are flush with housing.

## SERVER PRODUCTS LIMITED WARRANTY

### 2 YEAR WARRANTY

Server Products equipment is backed by a two-year limited warranty against defects in materials and workmanship.

For complete warranty information go to:

[www.Server-Products.com](http://www.Server-Products.com)

## GENERAL SERVICE, REPAIR OR RETURNS

Before sending any item to Server Products for service, repair, or return, contact Server Products customer service to request a **Return Authorization Number**. Merchandise must be sent to Server Products with this number. Service is extremely prompt. Typically, units are repaired and ship out within 48 hours of receipt.

Merchandise being returned for credit must be in new and unused condition and not more than 90 days old and will be subject to a 20% restocking charge.

## NEED HELP?

### Server Products Inc.

3601 Pleasant Hill Road  
Richfield, WI 53076 USA



262.628.5600 | 800.558.8722



[SPSALES@SERVER-PRODUCTS.COM](mailto:SPSALES@SERVER-PRODUCTS.COM)

Please be prepared with your **Model, Part, Series Number** and **Description**. This information is located on the lid and/or base of the unit.

Individual **Part Numbers** listed on pages 2, 3 and 4.

For part information on older models, or for other questions, please contact Server Products customer service department.