

ACCESSORY PARTS

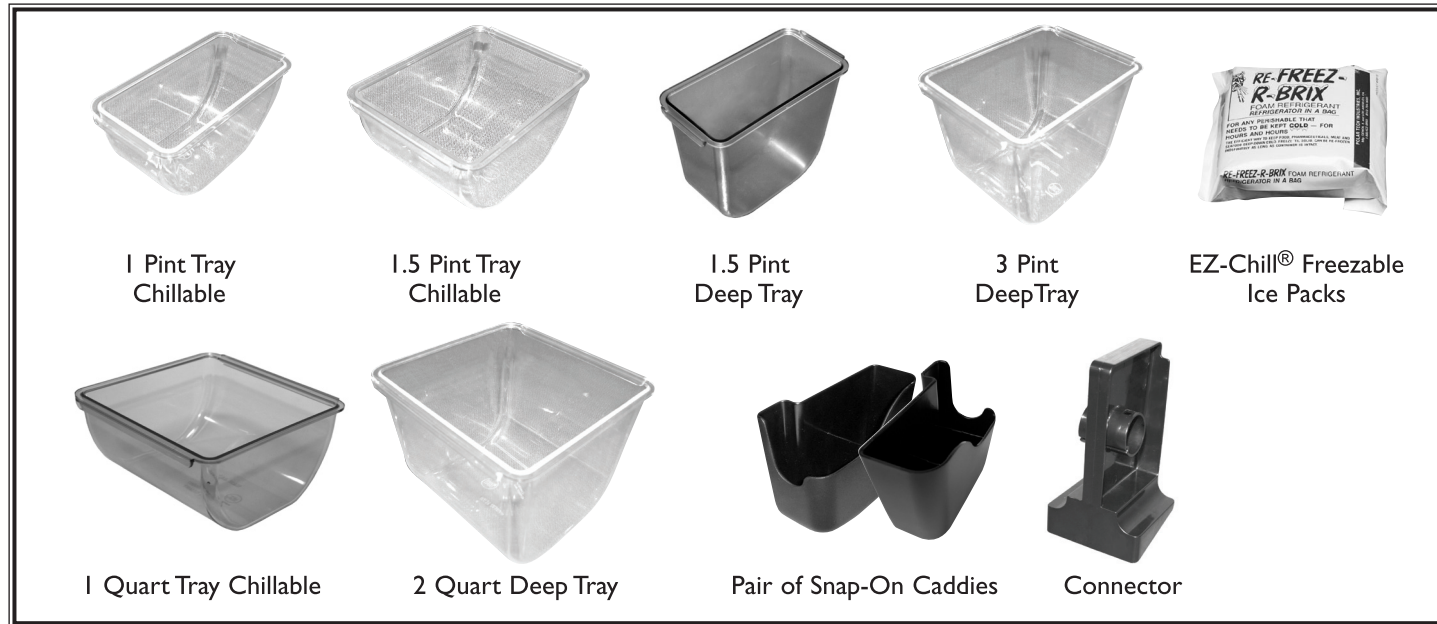

Tray	Item No	Carton Qty.	Added Depth For Extra Capacity	Chillable	Cube	Carton Wt
1 pint tray	BD101	12	N	Y	0.011	2.3 LBS
1.5 pint tray	BD102	6	N	Y	0.012	1.6 LBS
3 pint deep tray	BD103	6	Y	N	0.013	2.2 LBS
2 quart deep tray	BD104	6	Y	N	0.012	2.4 LBS
1.5 pint deep tray	BD105	6	Y	N	0.012	2.0 LBS
1 quart tray	BD106	6	N	Y	0.011	2.0 LBS
Connector	BD110	6	NA	NA	0.046	2.0 LBS
Snap-On Caddies	BS100S	1 pair	NA	NA	0.107	0.8 LBS
EZ-Chill® Ice Packs	B6180	6	NA	Y	0.160	6.1 LBS

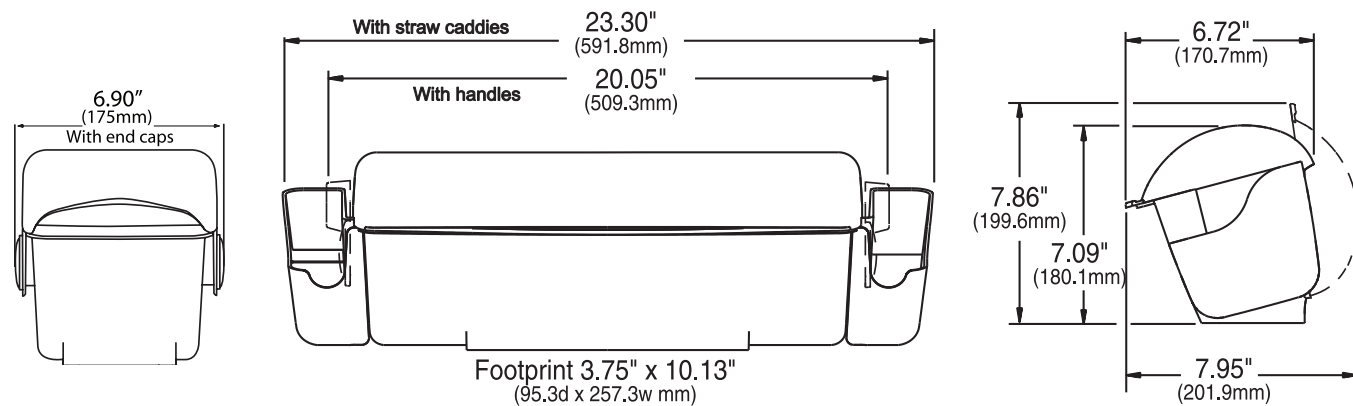

SAN JAMAR NSF

Smart ♦ Safe ♦ Sanitary

555 Koopman Lane • Elkhorn, Wisconsin 53121 USA
 T: (262) 723-6133 • F: (262) 723-4204
 Customer Care: (800) 248-9826 • www.sanjamar.com

San Jamar Europe, Inc.
 Schoorstraat 26A, Bus 1 B-2220 • Heist op-den Berg BELGIUM
 T: +32 (0) 1522 8140 F: +32 (0) 1522 8148

San Jamar Mexico, S de RL de CV
 Prolongación Av. San Antonio • No. 135 col. San Pedro de los Pinos
 Delegación Alvaro Obregón • C. P. 01180 en México, DF MEXICO
 T: +52 (55) 5575 4480

100436_RevC071001

See our catalog for more details and information about other innovative products from San Jamar.

The Dome®

The all-in-one
 Garnish and Condiment
 Serving Solution

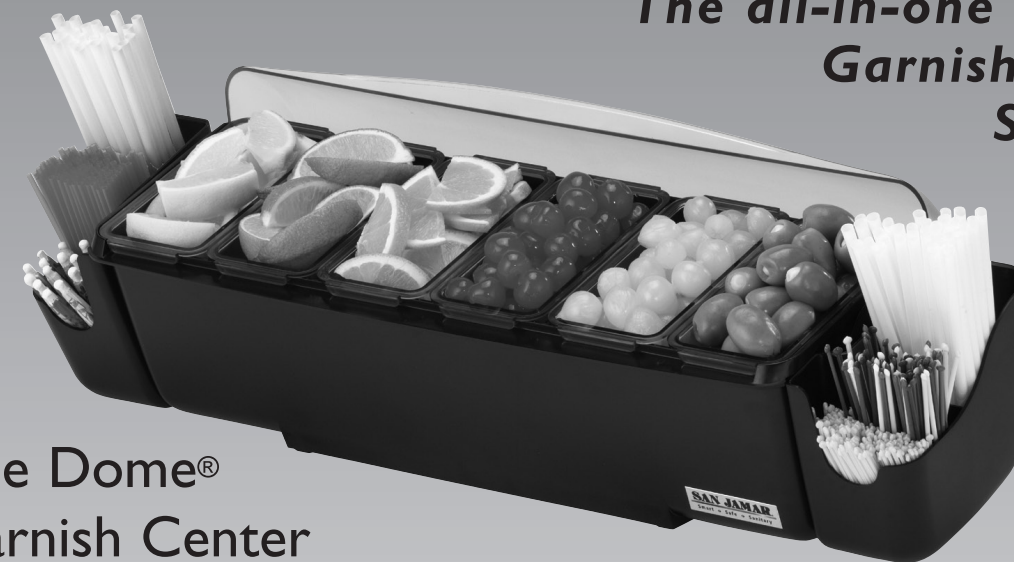

The Dome®
 Garnish Center



The Dome®
 Condiment
 Center



Mini Dome®

SAN JAMAR
 Smart ♦ Safe ♦ Sanitary



THE DOME® AND MINI DOME® CONTENTS

Thank you for choosing The Dome® garnish and condiment server from San Jamar. We appreciate your business and are confident that the smart design and innovative features of your Dome® will improve the image and efficiency of your operation. Enjoy!

The Dome®

*Included with each of the sets below: (1ea) Domed Cover, Base, Left Latch Lever, Right Latch lever; Left Handle/Right Handle or Caddies

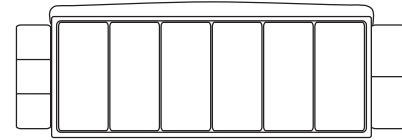
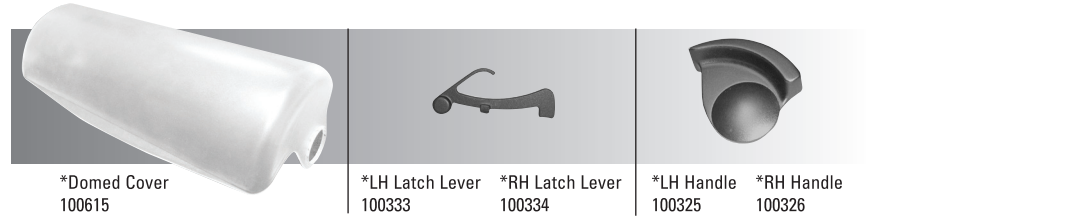

Item Number: **BD4006S**; Chillable
Weight: 4lbs. (1.81kgs)
Tray Configuration: (6) 1pt. trays, (2) straw caddies

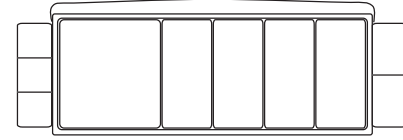

Item Number: **BD4005S**; Chillable
Weight: 4lbs. (1.81kgs)
Tray Configuration: (1) 2qt. tray, (4) 1pt. trays, (2) straw caddies

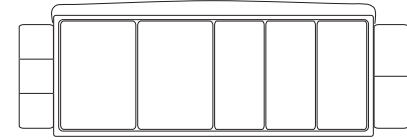

Item Number: **BD4023S**; Chillable
Weight: 4lbs. (1.81kgs.)
Tray Configuration: (2) 3pt., (3) 1pt. trays, (2) straw caddies

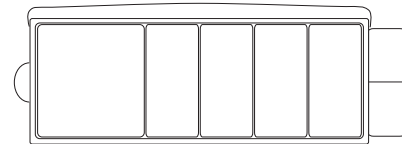
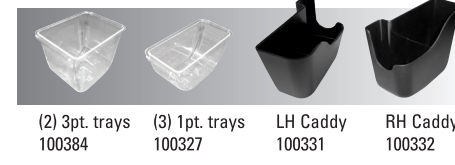

Item Number: **BD4005E**
Weight 4lbs.(1.81kgs.)
Tray Configuration: (1) 2qt. tray, (4) 1pt. trays, (1) straw caddy, (2) end caps

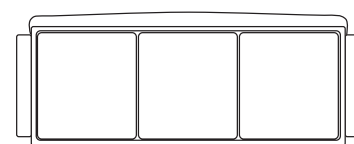

Item Number: **BD4003**
Weight 3.5lbs.(1.59kgs.)
Tray Configuration: (3) 2qt. trays

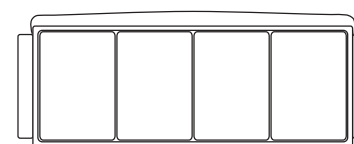

Item Number: **BD4004**
Weight: 3.5lbs. (1.59kgs.)
Tray Configuration: (4) 3pt. trays

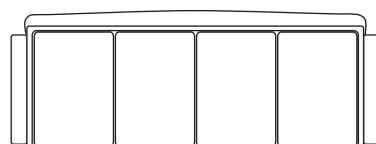

Item Number: **BD4014**; Chillable
Weight: 3.5lbs. (1.59kgs.)
Tray Configuration: (4) 1.5pt. trays

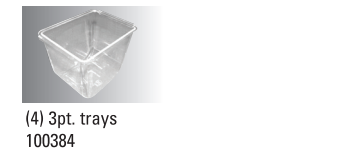
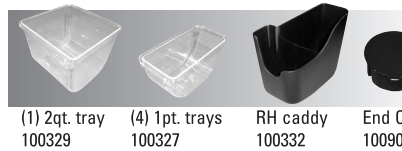

Mini Dome®

*Included with each of the sets below: (1ea) Domed Cover, Base, Left Latch Lever, Right Latch lever; (2) End Caps and (1) Connector

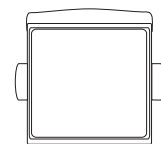
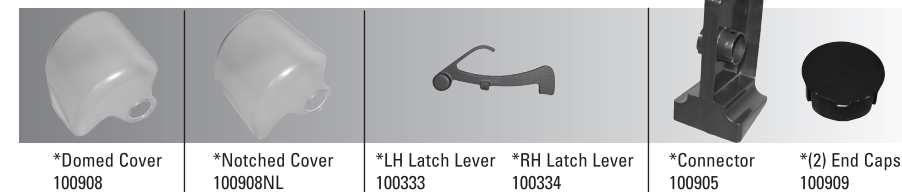

Item Number: **BD2001**
Weight: 2.0lbs. (0.91kgs.)
Tray Configuration: (1) 2 qt. tray

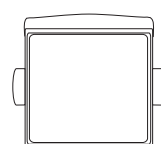

Item Number: **BD2002**; Chillable
Weight: 2.0lbs. (0.91kgs.)
Tray Configuration: (1) 1 qt. tray

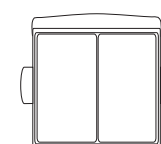

Item Number: **BD2003**; Chillable
Weight: 2.0lbs. (0.91kgs.)
Tray Configuration: (2) 1pt. trays

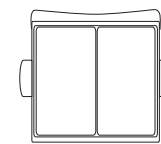

Item Number: **BD2004NL**
Weight: 2.0lbs. (0.91kgs.)
Tray Configuration: (2) 1.5pt. trays



DISASSEMBLY AND CLEANING

For new units clean and sanitize before use

HOW TO DISASSEMBLE THE UNIT

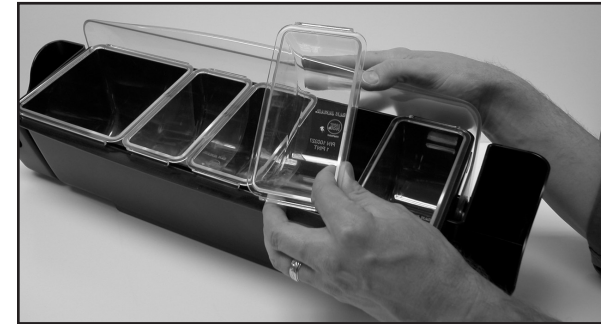

1. Pivot domed lid to open position and remove insert trays.



2. Locate a latch lever on rear of unit, gently lift lever and slide off caddy, handle, end cap or connector. Repeat on opposite side.



3. With lid closed, on one end of the domed lid, gently grasp the lid tab and bend just enough to remove lid from pivot post. Then slip the lid off opposite pivot post to remove completely.

4. Hand wash or clean in dishwasher. Clean and sanitize per local requirements. All components are dishwasher and warewasher safe.

5. Reverse the order of disassembly in order to reassemble.

Note: To maintain the "like new" condition of The Dome®, do not clean using abrasive cleaners or scouring pads.

The Dome® is constructed of durable materials. All Dome® components are easily removed without the use of tools. All Dome® components are dishwasher and refrigerator safe.



CHILLING INSTRUCTION:

The Dome® is leak-proof and its polymer construction insulates better than conventional stainless steel units. This makes The Dome® well suited for chilling garnishes or condiments using either ice or chill packs. You can chill garnishes or condiments if your unit was configured with either 1 pint or 1-1/2 pint "shallow" trays. If your unit was not configured with either of these shallow trays, they can be purchased separately - see page 4 for product details.

HANDLE AND CADDY INSTRUCTION:

All Dome® units are supplied with standard, removable snap on handles and may also be supplied with removable snap on caddies or end caps. Carry handles make for easy transport of the unit from kitchen to serving area or from serving area to refrigerator. One or both handles can be replaced with snap on caddies to create an all-in-one drink preparation or condiment station.

Note: Handles and caddies can be installed interchangeably, but a left handle can only be replaced with a left caddy, and a right handle can only be replaced with a right caddy. End caps and connectors are interchangeable from right side to left side.

TO INTERCONNECT DOME® UNITS TOGETHER:

The Connectors are designed to be installed only one way. Align the connecting hub to the mating hub on the side wall of the Base. Push Connector on until an audible snap is heard. When properly installed, the Connector should not be able to be removed from the Base without first lifting up the rear release lever.

Warnings:

- Do not transport/carry more than three Mini Dome® units together.
- Do not transport/carry more than two Full size Dome® units together.
- Do not transport/carry more than one Full size Dome® and one Mini Dome® unit together.
- With the exception of the three examples above, do not transport units while interconnected. Disconnect the Connector and carry as single units.