



FOOD EQUIPMENT

Easy Chopper II

- 56500-1 1/4" Cut Chop
- 56500-2 3/8" Cut Chop
- 56500-3 1/2" Cut Chop
- 56500-4 1" Cut Chop
- 56500-5 1/4" Cut Slice
- 56500-6 3/8" Cut Slice
- 56500-7 1/2" Cut Slice
- 56500-10 3/4" Cut Chop

OPERATING AND MAINTENANCE INSTRUCTIONS

Important

1. To get the best operation and life from your machine, please read and comply with these instructions.
2. Clean machine thoroughly before and after each use using cleaning instructions below.
3. Minimize the use of alkaline cleaners as they may cause pitting and dulling of the finish.

Safety Instructions

Remember that the blades are **VERY SHARP**; be careful when handling and operating the machine to keep hands away from the cutting edges.

Operation of Easy Chopper II

1. Place the chopper on a firm work surface.
2. Prepare the produce to be chopped (core, cut, slice to your specifications).
3. Lift HANDLE and place the produce on the blades.
4. Remove hand/fingers from the cutting area and with a strong, quick thrust, bring the PUSH BLOCK down to force the produce through the BLADES. Lift and repeat.
5. Clean the machine after chopping is completed using cleaning instructions below.

Caution: Do not attempt to chop produce larger than the opening in the BLADE HOLDER.

Note: Additional blade and PUSH BLOCK sets can be purchased separately. Be sure to always use a PUSH BLOCK and blade set that are compatible or damage to the machine may result. To check for compatibility, make sure the pusher fingers mesh with the blade set.

To cut 1/4" and 1/2", use 1/4" PUSH BLOCK

To cut 3/8" and 1", use 3/8" PUSH BLOCK

To Clean

1. Remove the PUSHER assembly, BUMPERS and BLADE AND HOLDER ASSEMBLY off the GUIDE RODS.
2. Thoroughly wash the PUSHER assembly, the BLADE ASSEMBLY, and the FRAME.
3. The PUSH BLOCK can be removed from the PUSH BLOCK GUIDE by removing THUMBSCREWS for further cleaning.
4. The chopping BLADE AND HOLDER ASSEMBLY may also be totally disassembled for further cleaning as follows:
 - a) Remove the SCREWS and the BLADE HOLDER PLATE.
 - b) Gently tap the BLADES and the BLADE SPACERS from the BLADE HOLDER.
5. To Reassemble:
 - a) Place the BLADE HOLDER on a table top with the BLADE SPACER pockets upward.
 - b) Insert the 4 BLADE SPACERS with their slots toward the inner opening of the BLADE HOLDER.
 - c) Insert BLADES with sharp edge downward and slots upward.
 - d) Insert BLADES with sharp edge and slots downward.
 - e) Reposition the BLADE HOLDER PLATE and secure with SCREWS.
6. Reposition BLADE AND HOLDER assembly, the BUMPERS, and the PUSHER assembly on the FRAME.

Chopping Tips

Cut produce before chopping and place a cut surface against the BLADES. Onions and tomatoes dice best if cut from top to bottom. They may be cut in half, or if smaller dices are desired, they can be cut several times in this direction.

To Lubricate

When needed, lubricate the GUIDE RODS with Mineral Oil, Food Grade Grease, or rub them with Paraffin. DO NOT LUBRICATE WITH COOKING OIL - IT GETS STICKY!

TO REPLACE BLADES OR BLADE SPACERS

If necessary, the BLADES and/or BLADE SPACERS can be replaced. To do this, follow Instruction 4-5 of TO CLEAN.

56500 - () EASY CHOPPER II

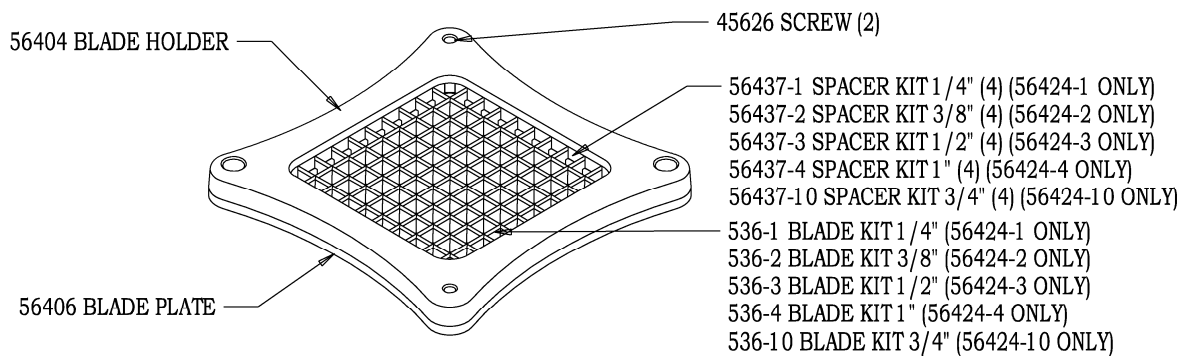
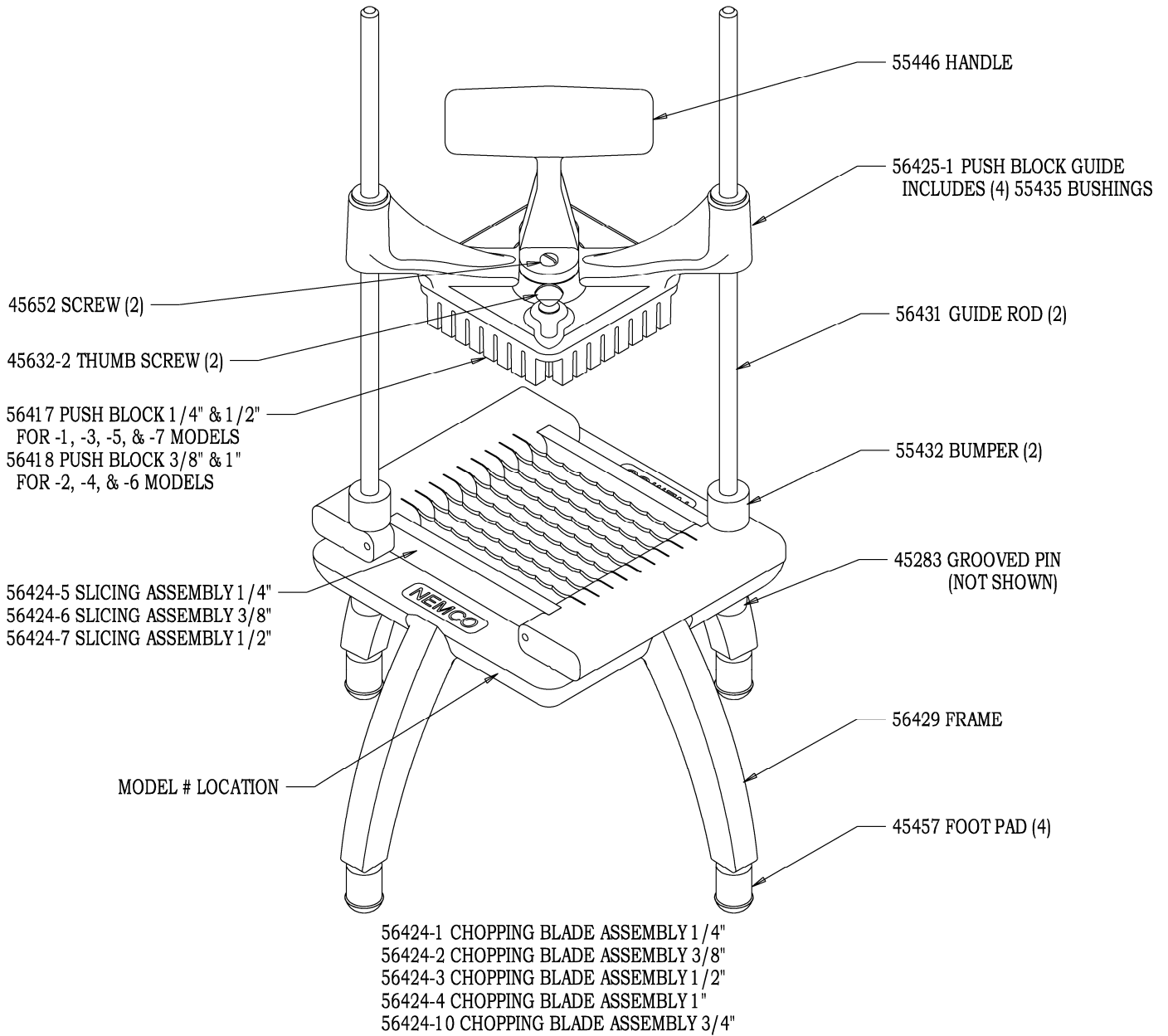

NEMCO FOOD EQUIPMENT

301 Meuse Argonne, Hicksville, OH 43526

Phone: (419) 542-7751 Fax: (419) 542-6690 Toll free: 1-800-782-6761 47064

www.nemcofoodequip.com

12-15-2010