

INSTRUCTION MANUAL

Gas Ranges

This manual contains important information regarding your unit. Please read this manual thoroughly prior to equipment set-up, operation and maintenance. Failure to comply with regular maintenance guidelines outlined in this manual may void the warranty.

WARNINGS

- Do not touch any hot surfaces
- Do not immerse unit in liquid at any time
- Do not operate unattended
- Do not use this unit for anything other than intended use
- Do not use outdoors
- Always use on a firm, dry and level surface at least 12" from walls or any other obstruction
- Keep children and animals away from unit
- Any incorrect installation, alterations, adjustments and/or improper maintenance can lead to property loss and injury. All repairs should be done by authorized professionals only.
- If gas odor is detected, shut unit down at main shutoff valve and contact service company
- Do not store or use gasoline or other flammable vapors or liquids in the vicinity of this or any appliance
- Do not ship or store upside down
- This unit should be stored in a well ventilated area that contains no corrosive gases.
- Do not get this unit wet
- This product is for commercial use only

BEFORE INSTALLATION

- Installation of this device should be operated by professional technicians
- This device is suitable for area whose altitude is lower than 6,500 ft. If it is higher than this altitude, please contact the manufacturer.
- Installation of this unit should conform to provisions of gas safety, installation and usage
- This device should be kept a minimum clearance of 4" away from non-combustible objects on both sides and 8" at the back (e.g. walls, windows etc.). Do not install on a flammable floor or around other combustible objects.
- This item is intended to sit on a solid and level floor

TO INSTALL

1. Level the device with a level gauge. The height can be adjusted by the adjustable feet.
2. The mounting position should be well-ventilated with proper hood exhaust system that will ensure that all the burnt gases produced during use are completely disposed of.
3. After installation, level the device and keep stable. Do not sway or tilt during operation.
4. A quick-acting switching-off gas valve should be installed upstream the device where is easy to be reached before installation.
5. Make sure you are using the correct gas supply that is specified for this model. If the gas supply is not intended for this model, do not proceed with installation.
6. This unit is applicable to low pressure regulating valves only. High pressure regulating valves and medium pressure regulating valves are not to be used.
7. Check to make sure the connection pipe to the unit has no leaks
8. If the connecting pipe pressure is 10% higher or lower than the rated pressure, please install a pressure regulator.
9. After connecting the appliance to the gas system, check for leaks at joints and pipe fittings; to do so, use soapy water or a specific leak detector (spray).
10. Check the gas supply pressure after installation.
11. Gas supply pressure can be measured with a liquid-filled pressure gauge (e.g. a U-shaped pressure gauge, minimum scale division 0.1mbar) or a digital gauge. Procedure as follows:
 - Remove the panel and unscrew the screw on the pressure port
 - Place the pressure gauge
 - Start up the appliance by following the instructions in this owner's manual
 - Check supply pressure
 - After the check, remove the pressure gauge
 - Replace the sealing screw

CODES AND STANDARDS

This item must be installed in accordance with:

In the United States:

State and local codes, or in the absence of local codes, with:

National Fuel Gas Code, ANSI-Z223.1/NFPA #54 (latest edition). Copies may be obtained from The American Gas Association Accredited Standards Committee Z223, @ 400 N. Capital St. NW, Washington, DC 20001 or the Secretary Standards Council, NFPA, 1 Batterymarch Park Quincy, MA 02169-7471.

NFPA Standard #96 Vapor Removal from Cooking Equipment, latest edition, available from the National Fire Protection Association, Batterymarch Park, Quincy, MA. In the commonwealth of Massachusetts all gas appliances vented through a ventilation hood or exhaust system with a damper or with a power means of exhaust shall comply with 248 CMR.

In Canada:

Local codes:

CAN/CSA-B149.1 Natural Gas Installation (latest edition).

CAN/CSA-B149.2 Propane Installation Code (latest edition), available from the Canadian Gas Association 178 Rexdale Blvd., Etobicoke, Ontario Canada M9W 1R3.



The installer of this unit should be aware of state, county or local code for connecting this equipment to determine if an external regulator is required

OPERATING INSTRUCTIONS AND CONTROLS

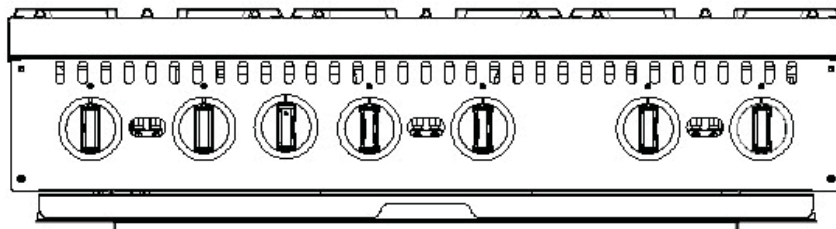
When turning on for the first time please be advised that it might take a little longer to ignite due to the air existing in the pipe. If the ignition does not light, turn off the ignition switch and wait 3 minutes to try again.



BURNERS

1. Connect the gas supply and ignite the pilot flame with a lighter. If the unit hasn't been used in a while or if this is the first lighting, ignition might take a little longer (about two or three minutes).
2. Press the corresponding valve knob of burner and turn 90 degrees counterclockwise. The burner will be ignited. If “  ” on the knob is aligned with the round dot on the panel, the flame is Max. To set the flame to Min, rotate counterclockwise to the Min flame position. “ ” is Min.
3. When finished turn off main burner by rotating the knob clockwise to off position.

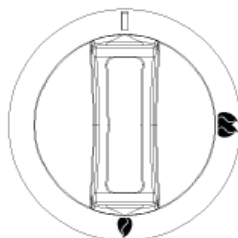

OVEN

Before using the oven, please clean the unit completely, especially the oven chamber. Remove all the packing materials and film from shipping. Before cleaning the stainless steel accessories, please make sure that the used detergent contains no corrosive substance and is okay for stainless steel surface cleaning. Then dry with a clean cloth.

When first using, it is normal that there is unpleasant smell. (Make sure that the smell is not caused by gas leakage.) In fact, that is produced by overheating of the insulating material and oil residue during heating process of the metal. If the oven is used for the first time, do not put any food into the chamber, set the temperature to 550°F and heat till the smell is gone. When first using, the duration of ignition may be a little longer due to the air existing in the new pipe. It cannot be ignited until all the air is exhausted.

1. During ignition, please open the lid under the door downward, press down the knob and rotate it counterclockwise to “”, align with the salient point and press down. Ignite the pilot flame with lighter via the ignition hole.
2. After the pilot flame is ignited, press the knob for more than 20 seconds to heat up the thermocouple. If the ignition is out when you loosen the knob, repeat this operation.
3. Keep rotating the temperature control knob counter-clockwise to ignite the main burner of the oven. Select appropriate
4. Temperature according to food requirement. The oven temperature can be controlled between 150°F and 550°F.
5. To turn off the burner: Rotate the knob clockwise to strip mark and align with the salient point.

GAS CONVERSION:

Conversion from Natural Gas to Liquid Propane (LP) or vice versa may only be performed by the factory or its authorized service agent. In case of troubleshooting, ensure the correct orifice sizes of the tips have been provided.

Orifice size is marked on the tip.

Top Burners:

Natural Gas Orifice is #36

Liquid Propane Gas Orifice is #50

Oven:

Natural Gas Orifice is #36

Liquid Propane Gas Orifice is #51

CLEANING - NOTE: It is important to check the machine daily. Checking the machine regularly can avoid serious accidents. Stop using if user feels that there are some problems with the unit. Check the situation of the machine before and after using every day.

Before using: Is the machine tilted?
Is the control panel damaged?

During use: Is there a strange smell or vibration noise?
Is the flame color of burner normal? Any light back or flameout?

1. Before cleaning, please turn off all gas valves.
2. Please clean the burners and tray for odds and ends regularly.
3. Clean the stainless steel surface with warm soapy water every day and rinse it completely. During cleaning, do not clean the stainless steel surface with abrasive detergent, brush or scraper etc. The residual iron scale may cause rusting.

4. Do not clean the surface with chlorine cleanser (bleach, hydrochloric acid etc.). Do not clean the floor where the device locates with corrosive substance (e.g. KCL).
5. Clean the dirt on the burners and baffle regularly.
6. Do not modify the ventilation volume needed during combustion.
7. Accumulation of the iron substance (e.g. Material that formed by iron rust dissolving in water in the pipe, especially when the device is not used for a long time.). Therefore, to avoid accumulation of such substance, clean the food swill that is difficult to clean with stainless steel scraper or brush containing no iron substance instead of steel brush.
8. Accumulation of substance containing acidic ingredient, e.g. vinegar, lemon juice, spices, salt etc. Thus, please keep these substances away from long contacting with the stainless steel accessories. Vapor of acid solution will damage the surface of the device seriously.
9. A complete cleaning every day will ensure a good service and extend the service life of the unit. Clean the unit with a wet towel containing suds or a detergent, rinse it with water and dry it with a clean cloth. Do not clean the device with steel brush, which may cause rust. Similarly, do not contact the unit with substance containing iron.
10. Splotch and abrasion of the stainless steel surface: Scrape and black stain can be cleared away by artificial sponge. During cleaning, the direction should be the same as the polishing.
11. Rusting: To remove the rusting, please contact the industrial detergent manufacturer to find a proper detergent to remove such rusting. Industrial rust removal products may do. After cleaning, rinse it with clear water. If necessary, neutralize the residual acid chemical compound with alkaline detergent.
12. To avoid rusting of the unit, please make sure that the residual salt inside or outside the device is cleared away.
13. After cleaning, to avoid short-time incomplete combustion, the fire hole of the burner should be clear.
14. If not going to use the item at any time, please turn off the gas valve upstream the device or the power main switch.
15. If not going to use the device for a long time, please clean the stainless steel surface with a gasoline cloth and store it in a well-ventilated area without corrosive gas.
16. 90% of the device is metals (stainless steel, iron, aluminum, galvanized metal sheet) which can be recycled by appointed treatment plant according to environmental standards of the equipment installation countries.

TROUBLESHOOTING

Problem	Possible Causes	Solution
The pilot flame can't be ignited	The gas pressure is too low	Adjust the relieve valve to increase pressure
The pilot flame can't be ignited	The nozzle is clogged	Unclog the nozzle
The pilot flame can't be ignited	Connection of the thermocouple is loose	Tighten the thermocouple
The pilot flame can't be ignited	The thermocouple is defective	Replace the thermocouple
The pilot flame can't be ignited	The gas control valve is malfunctioning	Replace the gas control valve
Problem	Possible Causes	Solution
The pilot flame is on but the main burner can't be ignited	The gas pressure is too low	Adjust the relieve valve to increase pressure
The pilot flame is on but the main burner can't be ignited	The main burner nozzle is clogged	Unclog the nozzle
The pilot flame is on but the main burner can't be ignited	The gas control valve is defective	Replace the gas control valve
Problem	Possible Causes	Solution
It has a light-back sound when the gas supply is turned off	Wrong orifice size for the gas supply	Install proper orifice
It has a light-back sound when the gas supply is turned off	The damper is too open	Adjust the damper
It has a light-back sound when the gas supply is turned off	The gas pressure is too low	Adjust the relieve valve
It has a light-back sound when the gas supply is turned off	Gas pressure too low	Increase the gas pressure
Problem	Possible Causes	Solution
It has a red flame and black smoke	Wrong orifice size for the gas supply	Install proper orifice
It has a red flame and black smoke	The damper is too closed	Adjust the damper
It has a red flame and black smoke	Running out of gas/propane	Replace tank/increase gas
It has a red flame and black smoke	High elevation	Install proper tips for elevation
It has a red flame and black smoke	Bad air/gas mixture	Increase air flow/gas to the unit

Parts Diagram for the Gas Ranges

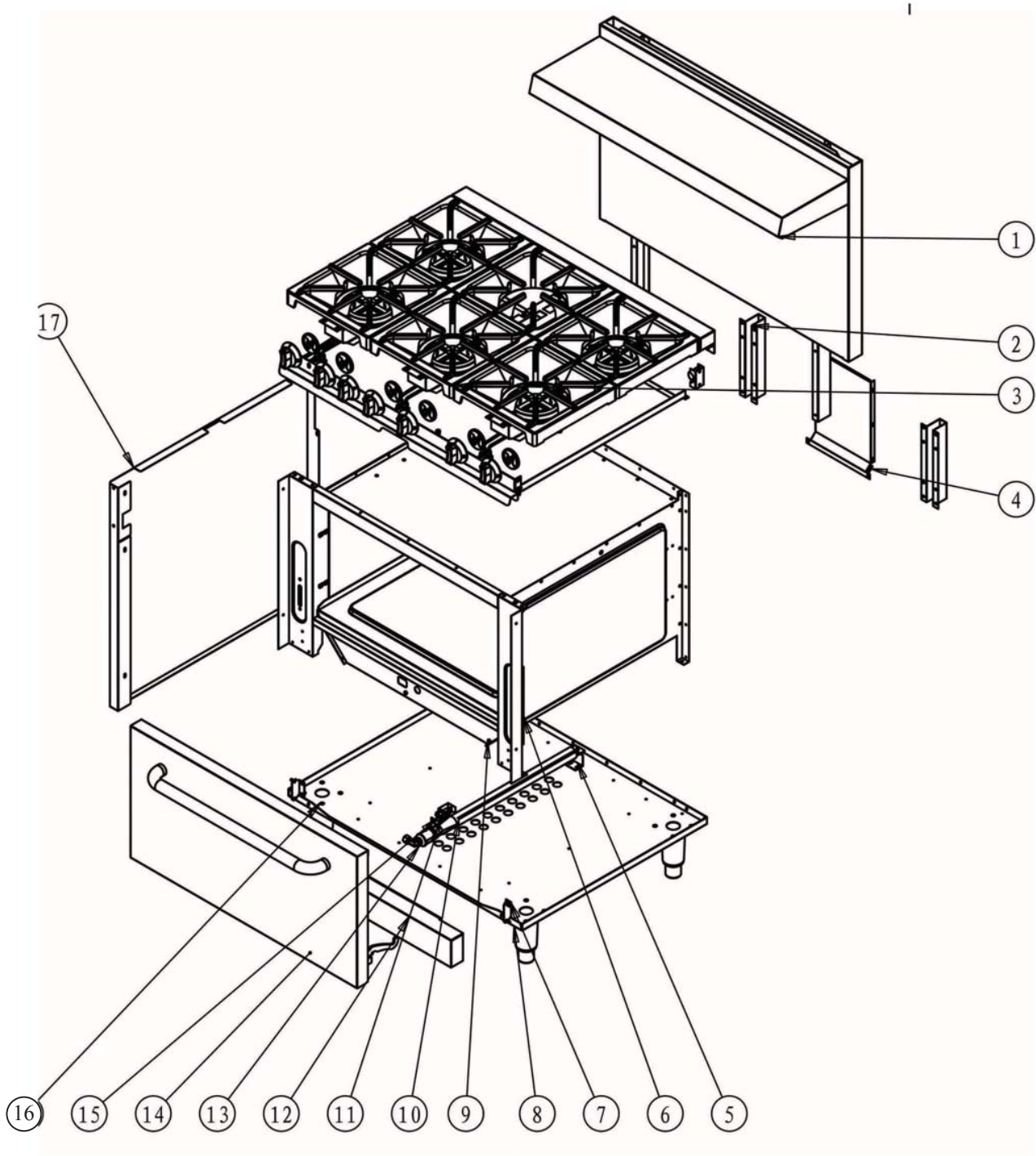

Parts Diagram shown for 6 burner model.
4 and 10 burner models use the same parts

Parts List for the Gas Convection Oven

Diagram Number	Description	Quantity for 4 Burner	Quantity for 6 Burner	Quantity for 10 Burner
1	Back Plate Assembly	1	1	1
2	Guide Trough for Back Plate	2	2	3
3	Gas Range Assembly	4	6	10
4	Inner Gas Chimney	1	1	2
5	Back Support for Burner	1	1	2
6	Oven Chamber Assembly	1	1	2
7	Hinge Assembly	2	2	4
8	Bottom Plate	1	1	2
9	Rivet	1	1	1
10	Pipe Burner	1	1	2
11	Pilot	1	1	2
12	Front Bottom Beam	1	1	2
13	Oven Nozzle Angle Connector	1	1	2
14	Oven Door Assembly	1	1	2
15	Pilot Support Fixed Plate	1	1	2
16	Adjustable Foot	4	4	6
17	Left Side Shell Plate	1	1	1
18	Right Side Shell Plate	1	1	1
19	Sabarf Gas Valve	1	1	2
20	Thermopile for Oven	1	1	2
21	Gas Valves for Hoteplate	4	6	10
22	Pilot for Hotplate	4	6	10
23	Door Hinge	2	2	4

WARRANTY

ACE warrants its equipment against defects in materials and workmanship, subject to the following conditions:

ACE Equipment is warranted for one year, effective from the date of purchase by the original owner. A copy of the original receipt or other proof of purchase is required to obtain warranty coverage. This warranty applies to the original owner only, and is not assignable.

The stainless steel fry tank has a five (5) year limited tank warranty. If during the first year, the tank is found to have a leak and is verified by an authorized service company, the entire fryer will be replaced. During years two through five, a new tank will be given.

Should any product fail to function in its intended manner under normal use within the limits defined in this warranty, at ACE's discretion, such product will be repaired, replaced with a refurbished unit, or replaced with a new unit by ACE, after defective unit has been inspected and defect has been confirmed. ACE does not assume any liability for extended delays in replacing any item beyond its control. This warranty does not apply to rubber and non-metallic synthetic parts that may need to be replaced due to normal usage, wear or lack of preventative maintenance.

This warranty covers products shipped into the 48 contiguous United States, Hawaii, and metropolitan areas of Alaska and Canada. Warranty coverage on products used outside the 48 contiguous United States, Hawaii and metropolitan areas of Alaska and Canada may vary.

The following conditions are not covered by warranty:

- Equipment failure relating to improper installation, improper utility connection or supply and problems due to improper ventilation.
- Equipment that has not properly been maintained, damage from improper cleaning, and water damage to controls.
- Equipment that has not been used in an appropriate manner, or has been subject to misuse, neglect, abuse, accident, alteration, negligence, damage during transit, delivery or installation, fire, flood, riot, or act of God.
- Equipment that has the model number or serial number removed or altered.
- Equipment on which the security seal has been broken.

If the equipment has been changed, altered, modified, or repaired without express written permission from ACE, then the manufacturer shall not be liable for any damages to any person or to any property, which may result from the use of this equipment thereafter.

This equipment is intended for commercial use only and this warranty is void if equipment is used in other than a commercial application.

For warranty and non-warranty related issues and technical support call NSA at 877-672-7740. Please have your model number, serial number and proof of purchase ready. It is not necessary to contact the place where you originally purchased your product from.

"THE FOREGOING WARRANTY IS IN LIEU OF ANY AND ALL WARRANTIES EXPRESSED OR IMPLIED INCLUDING ANY IMPLIED WARRANTY OF MERCHANTABILITY OR FITNESS FOR PARTICULAR PURPOSES AND CONSTITUTES THE ENTIRE LIABILITY OF ACE. IN NO EVENT DOES THE LIMITED WARRANTY EXTEND BEYOND THE TERMS STATED HEREIN."

Please fill out and return the warranty registration card below to the address provided

WARRANTY REGISTRATION CARD

MAIL CARD
IMMEDIATELY



This card must be mailed immediately after installation date for warranty to be in effect.

National Service America • 230 Park Ave, Suite 1000 • New York, NY • 10169

(Name of Business) (Dealer Purchased From)

(Address) (City) (State) (Zip Code)

(Model Number) (Serial Number)

This is to inform that I, _____
(Please print name of individual who owns business)

have had the above installed in my place of business _____
(Date of Purchase)

(Contact Phone Number) (Contact E-mail) (Signature of individual who owns Business)

The above warranties are in effect from this installation date, or 90 days, which ever comes first.