

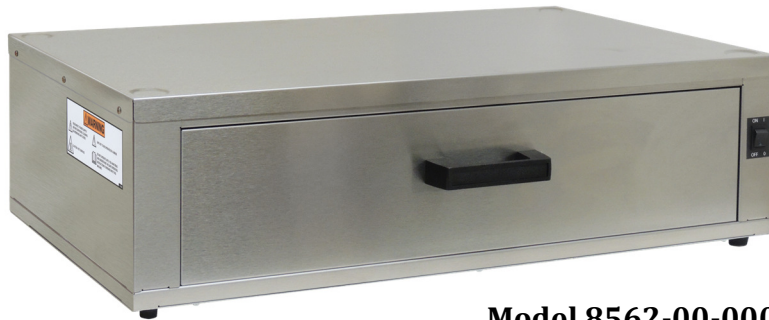

# Instruction Manual

## Bun Cabinets

Model No. 8560-00-000, 8561-00-000, and 8562-00-000



**Model 8562-00-000**



**Model 8561-00-000**



**Model 8560-00-000**







**GOLD MEDAL® PRODUCTS CO.**



10700 Medallion Drive, Cincinnati, Ohio 45241-4807 USA





# SAFETY PRECAUTIONS

	 <b>DANGER</b>
	<p>Machine must be properly grounded to prevent electrical shock to personnel. Failure to do so could result in serious injury, or death.                  DO NOT immerse any part of this equipment in water.                  DO NOT use excessive water when cleaning.                  Keep cord and plug off the ground and away from moisture.                  Always unplug the equipment before cleaning or servicing.                  Make sure all machine switches are in the OFF position before plugging the equipment into the receptacle.</p> <p style="text-align: right; font-size: small;">008_051514</p>

	 <b>DANGER</b>
	<p>Improper installation, adjustment, alteration, service, or maintenance can cause property damage, injury, or death. Any alterations to this equipment will void the warranty and may cause a dangerous condition. This appliance is not intended to be operated by means of an external timer or separate remote-control system. NEVER make alterations to this equipment. Read the Installation, Operating, and Maintenance Instructions thoroughly before installing, servicing, or operating this equipment.</p> <p style="text-align: right; font-size: small;">014_020416</p>

	 <b>WARNING</b>
	<p>To avoid burns, DO NOT touch heated surfaces.                  DO NOT place or leave objects in contact with heated surfaces.</p> <p style="text-align: right; font-size: small;">009_092414</p>



	 <b>WARNING</b>
	<p>ALWAYS wear safety glasses when servicing this equipment.</p> <p style="text-align: right; font-size: small;">010_010914</p>

	 <b>WARNING</b>
	<p>No user serviceable parts inside. Refer servicing to qualified service personnel.</p> <p style="text-align: right; font-size: small;">011_051514</p>

	 <b>WARNING</b>
	<p>Read and understand operator's manual and all other safety instructions before using this equipment. To order copies of the operator's manual go to <a href="http://gmpopcorn.com">gmpopcorn.com</a> or write to Gold Medal Products Co., 10700 Medallion Drive, Cincinnati, OH 45241 USA 1-(800)-543-0862</p> <p style="text-align: right; font-size: small;">022_060215</p>



## SAFETY PRECAUTIONS (continued)

	 <b>WARNING</b>
	DO NOT allow direct contact of this equipment by the public when used in food service locations. Only personnel trained and experienced in the equipment operation may operate this equipment. Carefully read all instructions before operation. <span style="float: right;">012_010914</span>

	 <b>WARNING</b>
	This machine is NOT to be operated by minors. <span style="float: right;">007_010914</span>

**Note:** Improvements are always being made to Gold Medal’s equipment. This information may not be the latest available for your purposes. It is critical that you call Gold Medal’s Technical Service Department at 1-800-543-0862 for any questions about your machine operations, replacement parts, or any service questions. (Gold Medal Products Co. does not assume any liability for injury due to careless handling and/or reckless operation of this equipment.) General images may be used in manual for reference only.



# INSTALLATION INSTRUCTIONS

## Inspection of Shipment

After unpacking, check thoroughly for any damage which may have occurred in transit. Claims should be filed immediately with the transportation company. The warranty does not cover damage that occurs in transit, or damage caused by abuse, or consequential damage due to the operation of this machine, since it is beyond our control (reference warranty in back of manual).

## Manual

Read and understand the operator's manual and all other safety instructions before using this equipment. To order copies of the operator's manual go to [gmpopcorn.com](http://gmpopcorn.com) or write to Gold Medal Products Co., 10700 Medallion Drive, Cincinnati, OH 45241 USA 1-(800)-543-0862.

## Model Description

**8560-00-000:** Small Bun Cabinet (19.5") with 1 drawer pan and insert rack.

**8561-00-000:** Mid-size Bun Cabinet (24.5") with 1 drawer pan and insert rack.

**8562-00-000:** Large Bun Cabinet (34") with 2 drawer pans and insert racks.

## Items Included with this Unit

- Manual and Warranty Registration Card
- Insert Rack (False Bottom) (PN 111983)
- IEC Power Cord (PN 102020)



## Setup

1. This unit has been tested at the factory.
2. Remove all packaging and tape prior to operation.
3. Place unit on a sturdy, level base for use.
4. There are locators on top of cabinet to stack a second bun cabinet or roller grill (if desired). Ensure unit is evenly positioned in the feet rest locations for stability.
5. After setup, the unit should be cleaned prior to use (see Care and Cleaning section of this manual).

## Electrical Requirements

The following power supply must be provided (reference unit Data Plate for Wattage requirement):

**120 V~, 60 Hz**

	 <b>DANGER</b>
	<p>Machine must be properly grounded to prevent electrical shock to personnel. Failure to do so could result in serious injury, or death.            DO NOT immerse any part of this equipment in water.            DO NOT use excessive water when cleaning.            Keep cord and plug off the ground and away from moisture.            Always unplug the equipment before cleaning or servicing.            Make sure all machine switches are in the OFF position before plugging the equipment into the receptacle.</p> <p style="text-align: right;">008_051514</p>

A certified electrician must furnish sufficient power for proper machine operation and install any supplied receptacle (reference unit Data Plate for model specific Volts AC, Hertz, and Wattage requirements). We recommend this equipment be on a dedicated and protected circuit. Failure to wire properly will void the warranty and may result in damage to the machine. It is Gold Medal Products Co.'s recommendation that this machine be plugged directly into a wall outlet. The use of extension cords is not recommended due to safety concerns, and may cause sacrificed and/or reduced performance. Make sure cord is located to prevent a trip hazard or unit upset.

## Before You Plug In Machine

1. Make sure all machine switches are OFF before plugging equipment into receptacle.
2. Make sure wall outlet can accept the grounded plugs (where applicable) on the power supply cord.
3. The wall outlet must have the proper polarity. If in doubt, have a competent electrician inspect the outlet and correct if necessary.
4. **DO NOT** use a grounded to un-grounded receptacle adapter (where applicable).
5. Install unit in a level position.

	 <b>CAUTION</b>
	<p>If the supply cord is damaged, it must be replaced by a special cord or assembly available from Gold Medal Products Co. or its service agent.</p> <p style="text-align: right;">038_062714</p>

# OPERATING INSTRUCTIONS

## Controls and Their Functions

### POWER SWITCH

ON/OFF lighted rocker switch - supplies power to the heating element.



## Operating Instructions

Each pan can hold 3 bags containing 8 buns each (buns left in bag – recommended method) or each pan can hold 28 buns (un-bagged).

### Buns in a sealed bag (recommended method):

Water should not be used with buns in a sealed bag as the bag will hold in the moisture from the buns.

1. Place sealed buns in drawer pan with insert rack, close drawer, and turn the Power Switch ON.



### Buns un-bagged:



1. Pour 1/2 cup of water in the bottom of the removable drawer pan to provide some steam for un-bagged buns.

**Note:** 1/2 cup of water should keep buns in good, moist condition for 4+ hours. If excessive water is used, buns near the water can get overly soggy and excessive condensation will collect on the “ceiling” inside the cabinet.

2. Place insert rack in pan, then place hot dog buns in the drawer pan, and close drawer.
3. Periodically check to see if water needs to be added. If the unit runs out of water, the buns may become hard and dried out.

## Care and Cleaning

	 <b>DANGER</b>
	<p>Machine must be properly grounded to prevent electrical shock to personnel. <b>DO NOT immerse in water.</b> DO NOT clean appliance with a water jet. Always unplug the equipment before cleaning or servicing.</p> <p style="text-align: right;">025_111616</p>

	 <b>WARNING</b>
	<p>To avoid burns, DO NOT touch heated surfaces. DO NOT place or leave objects in contact with heated surfaces.</p> <p style="text-align: right;">009_092414</p>

Good sanitation practice demands that all food preparation equipment be cleaned regularly (only use non-toxic, food grade cleaners). A clean looking, well-kept machine is one of the best ways of advertising your product.

Follow the directions below to clean and sanitize unit each day after use.

1. Turn machine OFF, unplug unit and allow it to cool before attempting to clean.
2. Do not leave water in unit when not in use. Lift the drawer pan and insert rack out of the drawer and take them to the sink to clean.

**To remove drawer and wipe out inside of cabinet (as needed):** Locate the release lever on each side of the drawer as shown below.

3. Clean unit with a soft cloth, dampened with soap and hot water.
4. Wipe stainless steel parts with a clean cloth and cleaner designed for stainless steel, such as Gold Medal Watchdog Stainless Cleaner (Item No. 2088).

**DO NOT** use oven cleaners or abrasive materials as they will damage parts of machine.



### To Remove Drawer:







1. **Open drawer fully.**
2. **Push both release levers DOWN.**
3. **Pull drawer from unit.**





# MAINTENANCE INSTRUCTIONS

	 <b>DANGER</b>
	<p>Machine must be properly grounded to prevent electrical shock to personnel. Failure to do so could result in serious injury, or death.                  DO NOT immerse any part of this equipment in water.                  DO NOT use excessive water when cleaning.                  Keep cord and plug off the ground and away from moisture.                  Always unplug the equipment before cleaning or servicing.                  Make sure all machine switches are in the OFF position before plugging the equipment into the receptacle.</p> <p style="text-align: right; font-size: small;">008_051514</p>

	 <b>DANGER</b>
	<p>Improper installation, adjustment, alteration, service, or maintenance can cause property damage, injury, or death. Any alterations to this equipment will void the warranty and may cause a dangerous condition. This appliance is not intended to be operated by means of an external timer or separate remote-control system. NEVER make alterations to this equipment. Read the Installation, Operating, and Maintenance Instructions thoroughly before installing, servicing, or operating this equipment.</p> <p style="text-align: right; font-size: small;">014_020416</p>

	 <b>WARNING</b>
	<p>No user serviceable parts inside. Refer servicing to qualified service personnel.</p> <p style="text-align: right; font-size: small;">011_051514</p>

	 <b>CAUTION</b>
	<p>THE FOLLOWING SECTIONS OF THIS MANUAL ARE INTENDED ONLY FOR QUALIFIED SERVICE PERSONNEL WHO ARE FAMILIAR WITH ELECTRICAL EQUIPMENT. THESE ARE NOT INTENDED FOR THE OPERATOR.</p> <p style="text-align: right; font-size: small;">027_010914</p>





## ORDERING SPARE PARTS

1. Identify the needed part by checking it against the photos, illustrations, and/or parts list. (General images may be used in manual for reference only.)
2. Use only approved replacement parts when servicing this unit.
3. When ordering, please include part number, part name, and quantity needed.
4. Please include your model number, serial number, and date of manufacture (located on the machine nameplate/data plate) with your order.
5. Address all parts orders to Parts Department, Gold Medal Products Co., 10700 Medallion Drive, Cincinnati, Ohio 45241-4807

or place orders by phone or online:

Phone: (800) 543-0862  
(513) 769-7676

Fax: (800) 542-1496  
(513) 769-8500

E-mail: [info@gmpopcorn.com](mailto:info@gmpopcorn.com)  
Web Page: [gmpopcorn.com](http://gmpopcorn.com)



# Bun Cabinet– Parts Breakdown

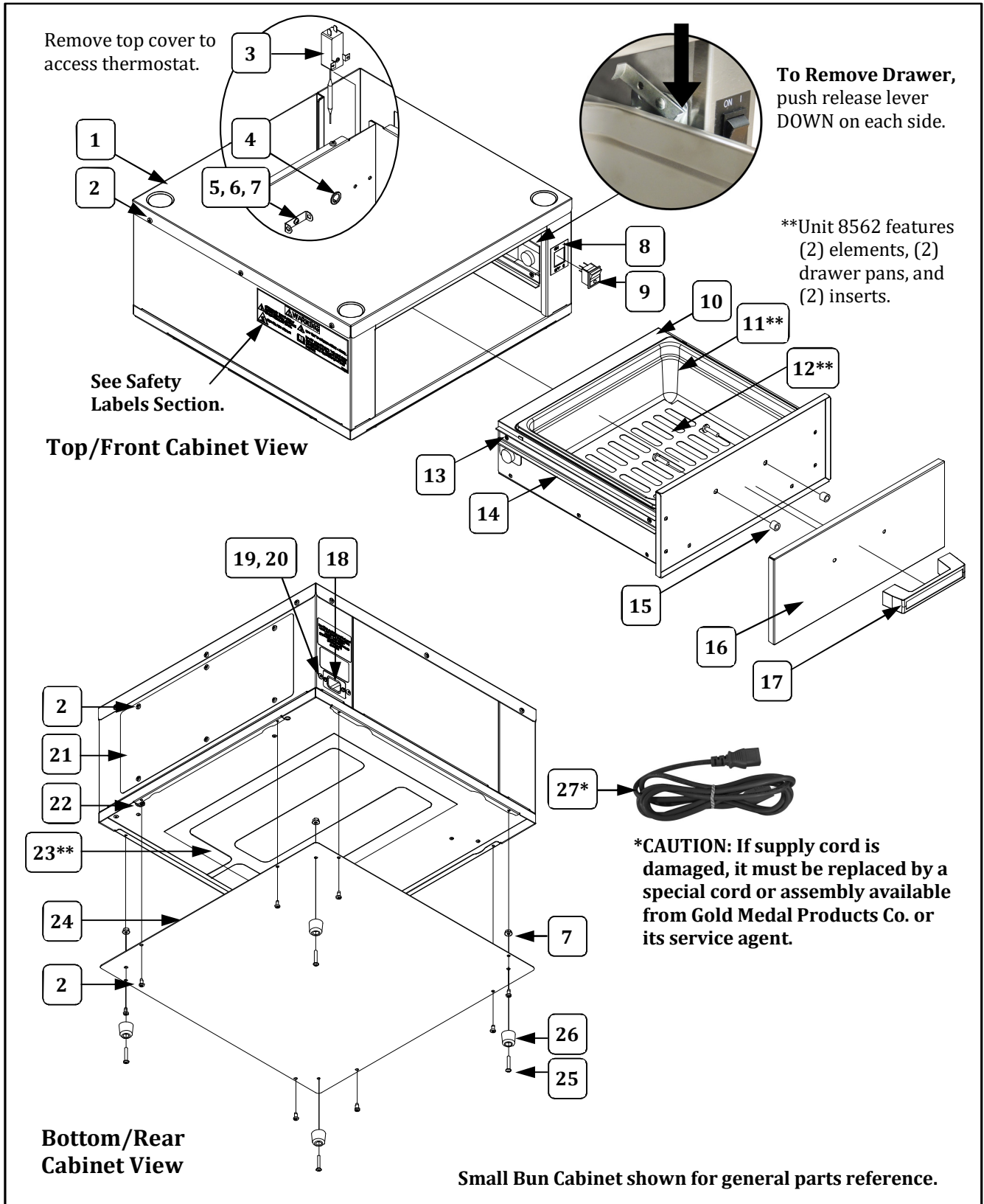



## Bun Cabinet – Parts List

Item	Part Description	Part Number		
		8560-00-000	8561-00-000	8562-00-000
1	DOME	111929	111942	111954
2	SCREW #8-32X3/8 PAN HD PH	74141	74141	74141
3	THERMOSTAT 125F BULB CAP	67923	67923	67923
4	BUSHING, SNAP .625 IN	47282	47282	47282
5	SENSOR BRACKET	40838	40838	40838
6	8-32 X 3/8 PAN HD PH M/S	12389	12389	12389
7	8-32 SERRATED FLANGE NUT	61151	61151	61151
8	ROCKER SW. LABEL ON/OFF	13015	13015	13015
9	SWITCH, LIGHTED ROCKER GR	47298	47298	47298
10	DRAWER BODY ASSEMBLY	111932	111943	111955
11**	2/3 X 4IN STEAM TABLE PAN (drawer pan)	111948	111948	111948
12**	FALSE BOTTOM (insert rack)	111983	111983	111983
13	8-32X3/8 SS FL HD PH MS (fastens drawer glides)	114421	114421	114421
14	DRAWER SLIDES 14IN (sold as a set, includes both RH and LH Drawer Slides)	114108	114108	114108
15	8020 SPACER	105016	105016	105016
16	DRAWER FRONT	111936	111947	111959
17	DRAWER HANDLE PLASTIC (includes 2 screws)	69191	69191	69191
18	IEC CONNECTOR,FLANGED	102013	102013	102013
19	6-32 X 3/8 PHIL PAN M/S	39000	39000	39000
20	6-32 GRIP NUT ZINC PLATED	47517	47517	47517
21	SIDE COVER	111930	111930	111930
22	BUSHING, SNAP .500 IN	47236	47236	47236
23**	150 WATT FOIL HEATER	114339	114339	114339
24	BOTTOM COVER	111928	111941	111953
25	8-32 X 1 PH PAN M/S S.S	12219	12219	12219
26	RUBBER FEET 3/4IN HIGH	47155	47155	47155
27	POWER CORD,16 AWG	102020	102020	102020

## Safety Labels

**1**

**2**

**3**

**4**

**Unit Labels**

**Power Cord Label**

Item	Part Description	Part Number
		All Models
1	LABEL	111931
2	MAIN GROUND LABEL	42375
3	CAUTION CORD SET LABEL	102032
4	WARNING LABEL CORD	68720



# Wiring Diagram

## Model No. 8560-00-000, 8561-00-000, and 8562-00-000

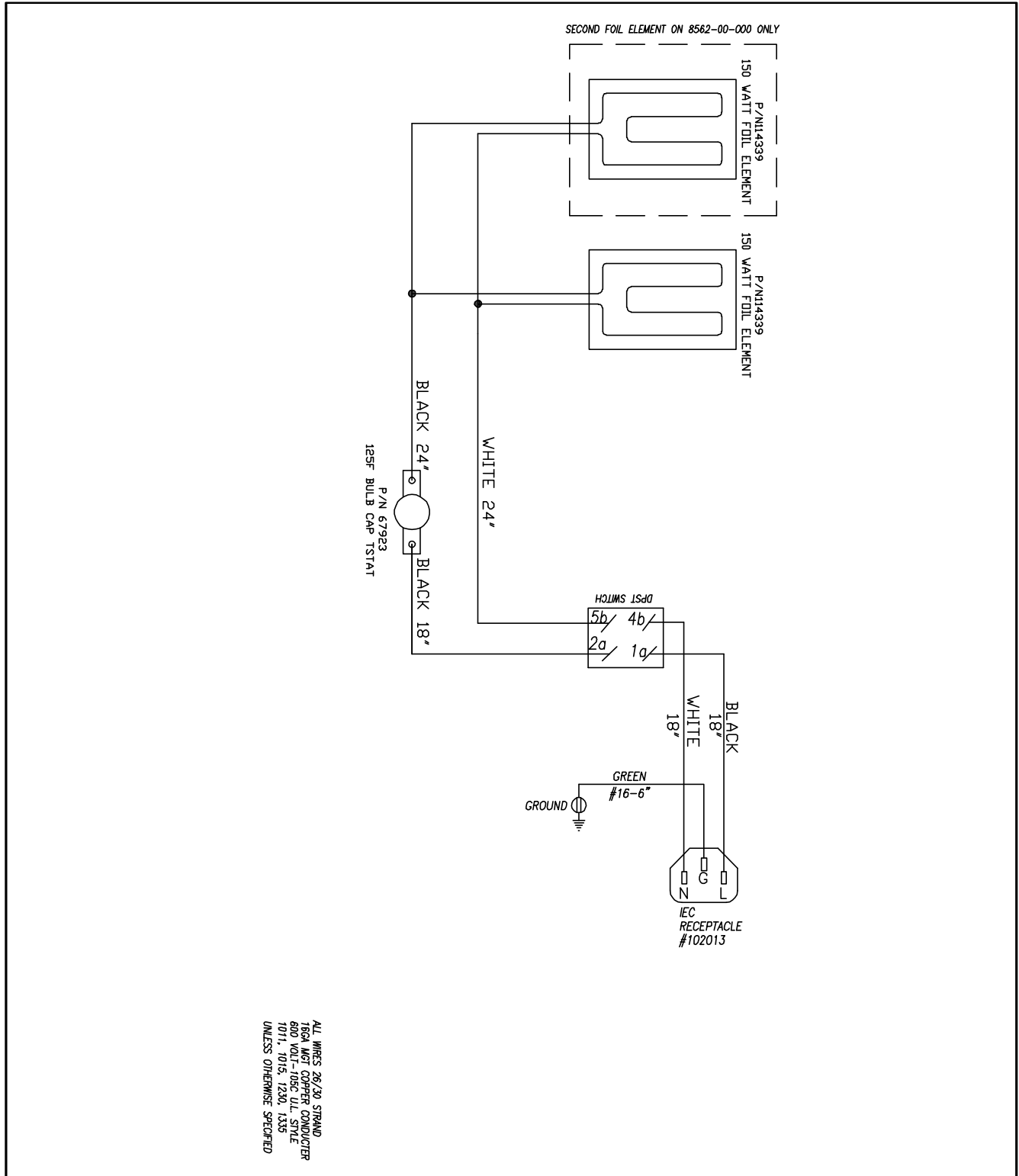



## WARRANTY

Gold Medal Products Co. warrants to the original purchaser each item of its manufacture to be free of defects in workmanship and material under normal use and service. Gold Medal Products Co.'s obligation under this warranty is limited solely to repairing or replacing parts, f.o.b. Cincinnati, Ohio, which in its judgment are defective in workmanship or material and which are returned, freight prepaid, to its Cincinnati, Ohio factory or other designated point. Except for "Perishable Parts" on specific machines, the above warranty applies for a period of two (2) years from the date of original sale to the original purchaser of equipment when recommended operating instructions and maintenance procedures have been followed. These are packed with the machine. Parts warranty is two (2) years, labor is six (6) months.

THIS WARRANTY IS IN LIEU OF ALL OTHER WARRANTIES EXPRESSED OR IMPLIED, AND OF ALL OTHER OBLIGATIONS OR LIABILITIES ON OUR PART, INCLUDING THE IMPLIED WARRANTY OF MERCHANTABILITY. THERE ARE NO WARRANTIES WHICH EXTEND BEYOND THE DESCRIPTION ON THE FACE HEREOF. In no event shall Gold Medal Products Co. be liable for special, incidental or consequential damages. No claim under this warranty will be honored if the equipment covered has been misused, neglected, damaged in transit, or has been tampered with or changed in any way. No claim under this warranty shall be honored in the event that components in the unit at the time of the claim were not supplied or approved by Gold Medal Products Co. This warranty is effective only when electrical items have been properly attached to city utility lines only at proper voltages. This warranty is not transferable without the written consent of Gold Medal Products Co.

The term "Original Purchaser" as used in this warranty shall be deemed to mean that person, firm, association, or corporation who was billed by the GOLD MEDAL PRODUCTS CO., or their authorized distributor for the equipment.

THIS WARRANTY HAS NO EFFECT AND IS VOID UNLESS THE ORIGINAL PURCHASER FIRST CALLS GOLD MEDAL PRODUCTS CO. AT 1-800-543-0862 TO DISCUSS WITH OUR SERVICE REPRESENTATIVE THE EQUIPMENT PROBLEM, AND, IF NECESSARY, FOR INSTRUCTIONS CONCERNING THE REPAIR OR REPLACEMENT OF PARTS.

*NOTE: This equipment is manufactured and sold for commercial use only.*



**GOLD MEDAL PRODUCTS CO.**

10700 Medallion Drive, Cincinnati, Ohio 45241-4807 USA

[gmpopcorn.com](http://gmpopcorn.com)

Phone: (800) 543-0862 Fax: (800) 542-1496  
(513) 769-7676 (513) 769-8500