

# BOLDER













## PIZZA PREP TABLE REFRIGERATORS



— DFS# 5003037 —

### Features & Benefits

-  The compressor is mounted in the back and placed in the coolest possible area; this makes it easily accessible for servicing.
-  Digital temperature controls with LED display for precise adjustment and automatic defrosting system.
-  Temperatures in the cabinet range from 33 to 41°F degrees Fahrenheit
-  Higher Resistance to dust, high quality condenser.
-  R290 Natural Refrigerant promotes faster cool down and efficient energy consumption.
-  Self-closing doors at 60° with stay open feature.
-  Stainless steel interior & exterior, sealed interior floors, and rounded cabinet corners for easy cleaning.
-  6" deep 1/3 plastic pan included.
-  High quality coated stainless adjustable shelves prevent peel and rust.
-  Lifetime warranty on hinges.
-  5" casters with lock for easy mobility.

### Technical Specifications

Voltage/Frequency	115V / 60Hz	Total Input Power	250W
Refrigerant	R290	Total Current	2.2A
Type of defrosting	Automatic	Climatic Category	4-5
Exterior Finish	Stainless Steel	Protection Type	I
Interior Finish	Stainless Steel	Design Pressure High Side	300 PSIG
		Design Pressure Low Side	150 PSIG
		Insulation Blowing Gas	C-Pentane



Tel: (888) 553-9255

Mail: [service@bolder-refrigeration.com](mailto:service@bolder-refrigeration.com)

# BOLDER

[www.bolder-refrigeration.com](http://www.bolder-refrigeration.com)

# PIZZA PREP TABLE REFRIGERATORS

Front View

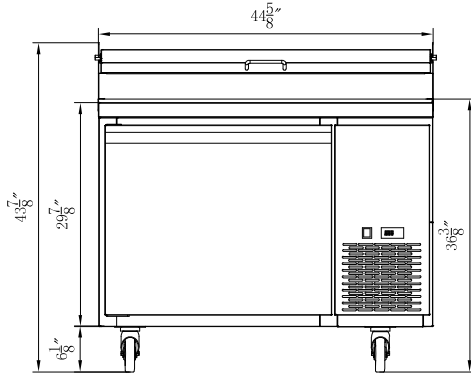

Side View

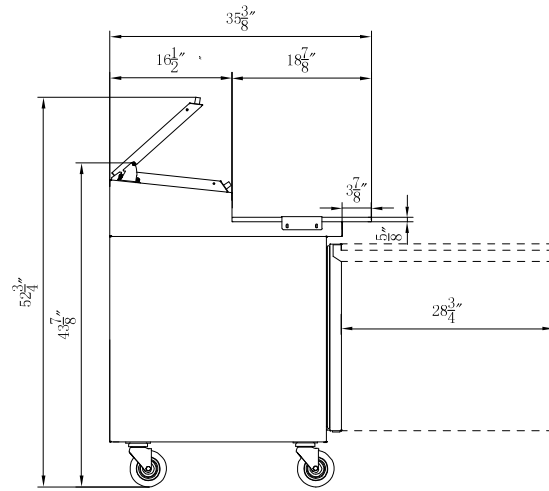

— DFS# 5003037 —

## 6x1/3 PAN

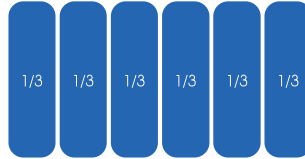

### Technical Specifications

Voltage/Frequency	115V / 60Hz	Total Input Power	250W
Refrigerant	R290	Total Current	2.2A
Type of defrosting	Automatic	Climatic Category	4-5
Exterior Finish	Stainless Steel	Protection Type	I
Interior Finish	Stainless Steel	Design Pressure High Side	300 PSIG
		Design Pressure Low Side	150 PSIG
		Insulation Blowing Gas	C-Pentane

PIZZA PREP TABLE REFRIGERATORS															
Model	External Dimensions (inches)			Packing Carton (inches)			Temperature Range (°F)	Compressor Power (HP)	Net Weight (lbs)	Gross Weight (lbs)	# of Shelves	NEMA Config.	Capacity (cu ft)	40HQ Container Certification	
	W	D	H	W	D	H									
DFS# 5003037	44 5/8	31 1/2	43 7/8	46 1/8	35 7/8	48 3/8	33 ~ 41°F	1/5	224	354	1	5-15P	9.88	46	



Tel: (888) 553-9255

Mail: [service@bolder-refrigeration.com](mailto:service@bolder-refrigeration.com)



[www.bolder-refrigeration.com](http://www.bolder-refrigeration.com)