

BOLDER



UNDERCOUNTER 3-SOLID DOOR REFRIGERATORS

33 ~ 41°F



— DFS# 5003028 —

Features & Benefits

-  The compressor is mounted in the back and placed in the coolest possible area; this makes it easily accessible for servicing.
-  Digital temperature controls with LED display for precise adjustment and automatic defrosting system.
-  Temperatures in the cabinet range from 33 to 41°F degrees Fahrenheit
-  Higher Resistance to dust, high quality condenser.
-  R290 Natural Refrigerant promotes faster cool down and efficient energy consumption.
-  Self-closing doors at 60° with stay open feature.
-  Stainless steel interior & exterior, sealed interior floors, and rounded cabinet corners for easy cleaning.
-  High quality coated stainless adjustable shelves prevent peel and rust.
-  Lifetime warranty on hinges.
-  5" casters with lock for easy mobility.

Technical Specifications

Voltage/Frequency	115V / 60Hz	Total Input Power	380W
Refrigerant	R290	Total Current	3.4A
Type of defrosting	Automatic	Climatic Category	4-5
Exterior Finish	Stainless Steel	Protection Type	I
Interior Finish	Stainless Steel	Design Pressure High Side	300 PSIG
		Design Pressure Low Side	150 PSIG
		Insulation Blowing Gas	C-Pentane



Tel: (888) 553-9255

Mail: service@bolder-refrigeration.com

BOLDER

www.bolder-refrigeration.com

UNDERCOUNTER 3-SOLID DOOR REFRIGERATORS

Front View

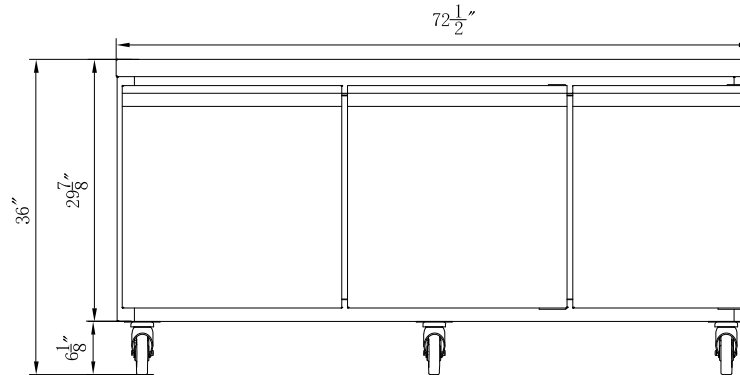

— DFS# 5003028 —

Side View

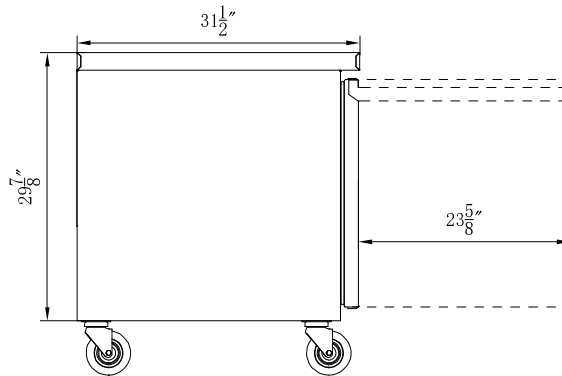

— DFS# 5003028 —

Technical Specifications

Voltage/Frequency	115V / 60Hz	Total Input Power	380W
Refrigerant	R290	Total Current	3.4A
Type of defrosting	Automatic	Climatic Category	4-5
Exterior Finish	Stainless Steel	Protection Type	I
Interior Finish	Stainless Steel	Design Pressure High Side	300 PSIG
		Design Pressure Low Side	150 PSIG
		Insulation Blowing Gas	C-Pentane

UNDERCOUNTER 3-SOLID DOOR REFRIGERATORS														
Model	External Dimensions (inches)			Packing Carton (inches)			Temperature Range (°F)	Compressor Power (HP)	Net Weight (lbs)	Gross Weight (lbs)	# of Shelves	NEMA Config.	Capacity (cu ft)	40HQ Container Certification
	W	D	H	W	D	H								
DFS# 5003028	72 1/2	31 1/2	36	73 7/8	33 1/8	39 3/8	33 ~ 41°F	1/3	242	367	3	5-15P	18.96	28



Tel: (888) 553-9255

Mail: service@bolder-refrigeration.com

BOLDER

www.bolder-refrigeration.com