



Instruction Manual

Dual Chili & Cheese Dispenser

Model No. 5301



GOLD MEDAL® PRODUCTS CO.

10700 Medallion Drive, Cincinnati, Ohio 45241-4807 USA



Table of Contents

SAFETY PRECAUTIONS 3

INSTALLATION INSTRUCTIONS..... 5

 Inspection of Shipment5

 Manual.....5

 Model Description5

 Items Included with this Unit.....5

 Setup5

 Electrical Requirements6

 Before You Plug In Machine.....6

OPERATING INSTRUCTIONS..... 7

 Controls and Their Functions7

 Operating Instructions7

Adjusting the Set Temperature..... 8

Product Installation and Removal 9

Care and Cleaning 11

Troubleshooting 12

MAINTENANCE INSTRUCTIONS..... 13

ORDERING SPARE PARTS..... 14

 Cabinet Exterior – Decals and Bottom View15



 Cabinet Front View - Interior.....16



 Cabinet Back View – Interior/Exterior.....17



Wiring Diagram..... 18



WARRANTY..... 19



SAFETY PRECAUTIONS

	 DANGER
	<p>Machine must be properly grounded to prevent electrical shock to personnel. Failure to do so could result in serious injury, or death. DO NOT immerse any part of this equipment in water. DO NOT use excessive water when cleaning. Keep cord and plug off the ground and away from moisture. Always unplug the equipment before cleaning or servicing. Make sure all machine switches are in the OFF position before plugging the equipment into the receptacle.</p> <p style="text-align: right; font-size: small;">008_051514</p>

	 DANGER
	<p>Improper installation, adjustment, alteration, service, or maintenance can cause property damage, injury, or death. Any alterations to this equipment will void the warranty and may cause a dangerous condition. This appliance is not intended to be operated by means of an external timer or separate remote-control system. NEVER make alterations to this equipment. Read the Installation, Operating, and Maintenance Instructions thoroughly before installing, servicing, or operating this equipment.</p> <p style="text-align: right; font-size: small;">014_020416</p>



	 WARNING
	<p>To avoid burns, DO NOT touch heated surfaces. DO NOT place or leave objects in contact with heated surfaces.</p> <p style="text-align: right; font-size: small;">009_092414</p>

	 WARNING
	<p>ALWAYS wear safety glasses when servicing this equipment.</p> <p style="text-align: right; font-size: small;">010_010914</p>

	 WARNING
	<p>No user serviceable parts inside. Refer servicing to qualified service personnel.</p> <p style="text-align: right; font-size: small;">011_051514</p>

	 WARNING
	<p>Read and understand operator's manual and all other safety instructions before using this equipment. To order copies of the operator's manual go to gmpopcorn.com or write to Gold Medal Products Co., 10700 Medallion Drive, Cincinnati, OH 45241 USA 1-(800)-543-0862</p> <p style="text-align: right; font-size: small;">022_060215</p>



	 WARNING
	DO NOT allow direct contact of this equipment by the public when used in food service locations. Only personnel trained and experienced in the equipment operation may operate this equipment. Carefully read all instructions before operation. 012_010914

	 WARNING
	This machine is NOT to be operated by minors. 007_010914

Note: Improvements are always being made to Gold Medal’s equipment. This information may not be the latest available for your purposes. It is critical that you call Gold Medal’s Technical Service Department at 1-800-543-0862 for any questions about your machine operations, replacement parts, or any service questions. (Gold Medal Products Co. does not assume any liability for injury due to careless handling and/or reckless operation of this equipment.) General images may be used in manual for reference only.



INSTALLATION INSTRUCTIONS

Inspection of Shipment

After unpacking, check thoroughly for any damage which may have occurred in transit. Claims should be filed immediately with the transportation company. The warranty does not cover damage that occurs in transit, or damage caused by abuse, or consequential damage due to the operation of this machine, since it is beyond our control (reference warranty in back of manual).

Manual

Read and understand the operator's manual and all other safety instructions before using this equipment. To order copies of the operator's manual go to gmpopcorn.com or write to Gold Medal Products Co., 10700 Medallion Drive, Cincinnati, OH 45241 USA 1-(800)-543-0862.

Model Description

5301: Dual Chili and Cheese Dispenser with Digital Heat Control and 2 dispense buttons.

Items Included with this Unit

- Manual and Warranty Registration Card
- Basket Liner (PN 100557) (reference Product Installation section for use)

Setup

This unit has been tested at the factory.



1. Remove all packaging and tape prior to operation.
2. Place unit on a sturdy, level base for use.
3. After setup, the unit should be cleaned prior to use (see Care and Cleaning section of this manual).



Electrical Requirements

The following power supply must be provided (reference unit Data Plate for Wattage requirement):

120 V~, 60Hz

	 DANGER
	<p>Machine must be properly grounded to prevent electrical shock to personnel. Failure to do so could result in serious injury, or death. DO NOT immerse any part of this equipment in water. DO NOT use excessive water when cleaning. Keep cord and plug off the ground and away from moisture. Always unplug the equipment before cleaning or servicing. Make sure all machine switches are in the OFF position before plugging the equipment into the receptacle.</p> <p style="text-align: right; font-size: small;">008_051514</p>

A certified electrician must furnish sufficient power for proper machine operation and install any supplied receptacle (reference unit Data Plate for model specific Volts AC, Hertz, and Wattage requirements). We recommend this equipment be on a dedicated and protected circuit. Failure to wire properly will void the warranty and may result in damage to the machine. It is Gold Medal Products Co.'s recommendation that this machine be plugged directly into a wall outlet. The use of extension cords is not recommended due to safety concerns, and may cause sacrificed and/or reduced performance. Make sure cord is located to prevent a trip hazard or unit upset. Units with an IEC Power Cord - make sure the IEC cord is properly seated into the IEC receptacle before powering up the machine.

Before You Plug In Machine

1. Make sure all machine switches are OFF before plugging equipment into receptacle.
2. Make sure wall outlet can accept the grounded plugs (where applicable) on the power supply cord.
3. The wall outlet must have the proper polarity. If in doubt, have a competent electrician inspect the outlet and correct if necessary.
4. **DO NOT** use a grounded to un-grounded receptacle adapter (where applicable).
5. Install unit in a level position.

	 CAUTION
	<p>If the supply cord is damaged, it must be replaced by Gold Medal Products Co., its service agent or similarly qualified persons in order to avoid a hazard.</p> <p style="text-align: right; font-size: small;">039_080614</p>



OPERATING INSTRUCTIONS

Controls and Their Functions

POWER SWITCH - Turns the unit ON/OFF, and supplies power to the Digital Heat Control.

CHILI BUTTON - Push button to dispense Chili, release button to stop dispensing.

CHEESE BUTTON - Push button to dispense Cheese, release button to stop dispensing.

DIGITAL HEAT CONTROL (Digital Display)

This device controls (and displays) the air temperature of the cabinet. The control will display the temperature as long as the main power is on. To adjust the set temperature (program the Digital Heat Control), see Adjusting the Set Temperature section.

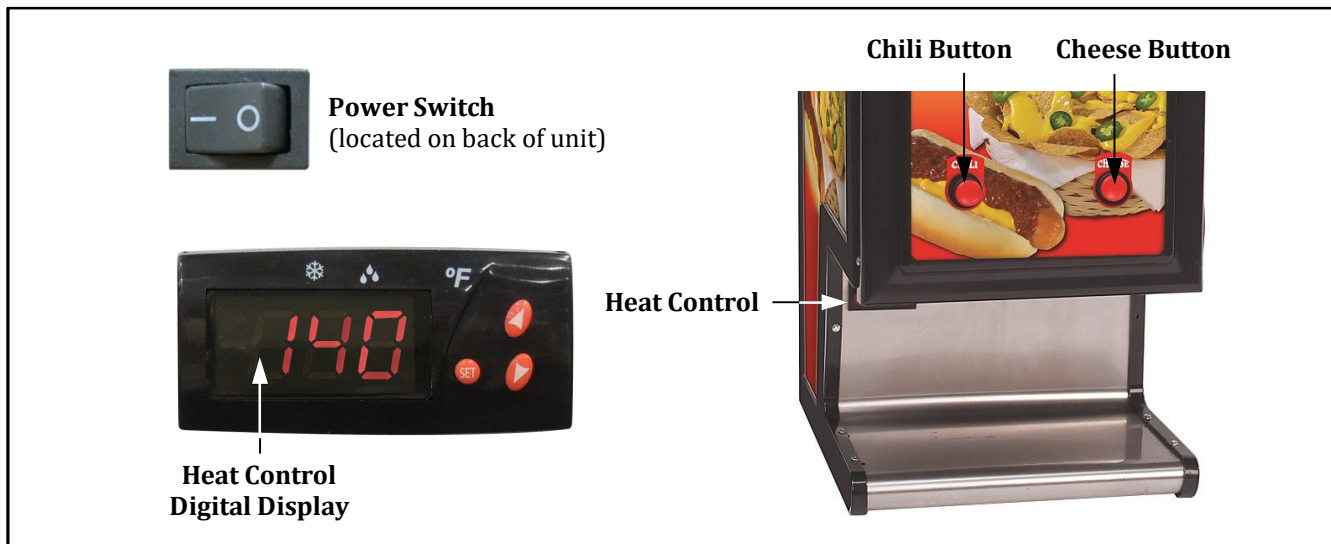

Operating Instructions

1. Turn Power Switch ON.
2. Pre-heat unit with unopened product inside (depending on the starting temperature of the cheese or chili, the unit may take 2-4 hours to reach set point temperature).

Important: The control displays the air temperature in the cabinet; it is factory set to 140°F (60°C). **The actual product temperature may be lower or higher than the displayed temperature depending on how long it has been heated.**

For specific product safe food holding temperature, reference your local code and/or instructions from the food product manufacturer.

3. Install preheated product (reference Product Installation section), then position a tray to receive product, and press dispense button for desired amount.

Turn off the power and unplug the machine at the end of each day. DO NOT leave the unit operating unattended.



Adjusting the Set Temperature

The unit comes from the factory with the Digital Heat Control preset to 140°F (60°C). The temperature range of the control can be set between 130°F (54°C) to 145°F (62°C). Follow the steps below to adjust this preset temperature.

1. Press “SET” button on the Digital Heat Control, and “SP” will appear. Press “SET” again to display current set temperature.
2. Press the “UP/DOWN” arrows to adjust to the desired temperature. Press “SET” to save.
3. Press “SET” and the “DOWN” arrow at the same time to return to operating mode.

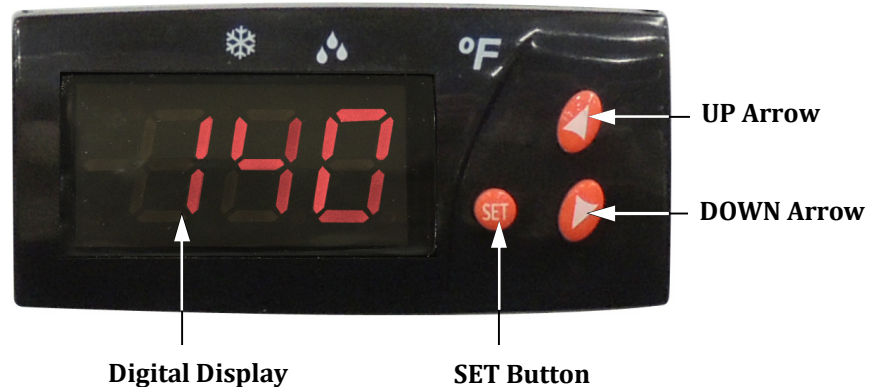

Digital Heat Control

Product Installation and Removal

Add a Basket Liner (PN 100557) to each Bag Support Tray opening to provide cushion/support for a product bag with the small cap. Follow instructions below to install the liners and insert product.

Basket Liner Installation

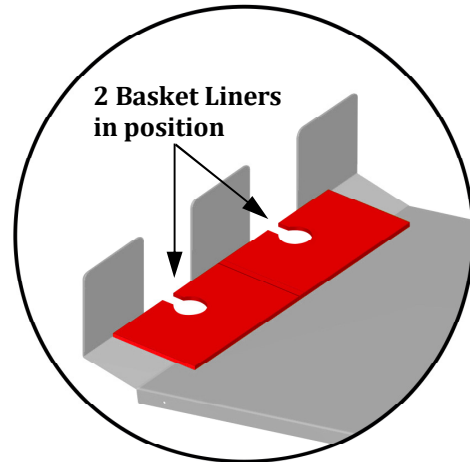

Inside view of Bag Support Tray

Step 1. Open the cabinet door and locate the Bag Support Tray. **Caution:** Tray may be hot when adding or changing the product.

Step 2. Position a Basket Liner as shown above for each tray opening.

Product Installation

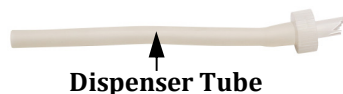

Step 1: Pull ring to remove fitting cover from a preheated product bag. Use a new dispenser tube (PN 5285) for each bag.



Step 2: The dispenser tube will pierce the inner seal of the bag when installed. Make sure the cap is securely threaded onto the bag fitting. **Caution:** Product may be hot.

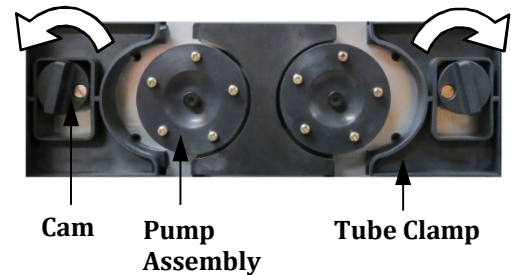

Step 3: Open the front door of the dispenser. Open the tube clamps by turning both cams in the direction away from the pump assembly (see image above).



Step 4: Place the product in support tray with spout and tube directed toward the front, and downward through the tray opening.

Note: The pan tray is required to keep the product in the tubes at the proper temperature (see image shown). Without the pan tray, the chili and cheese will not reach the correct temperatures.

Basket Liners must be in position
(for product bags with a small cap).

Step 5: Guide the tube through the pump slots from top to bottom, and pass the tubes through the pan tray.



Pan Tray

Step 6: Close the tube clamps by turning the cams in towards the pump assembly, and then close the dispenser door.

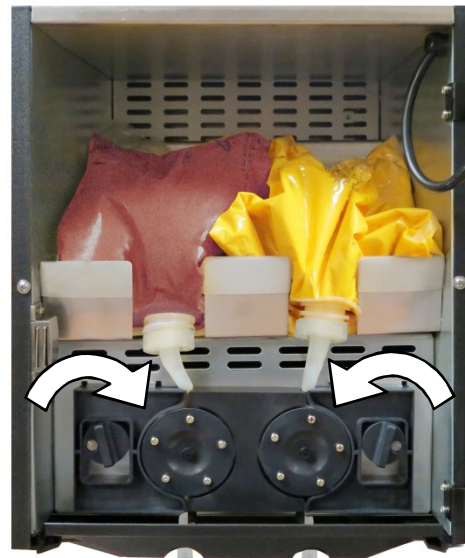



Product Removal:

1. Open the front door of the unit.
2. Open Tube Clamp (see Step 3 of Product Installation).
3. Remove tubing, by pulling from the bottom up.
4. Remove product bag and tube from the dispenser. Reuse the basket liner for the next bag.



Care and Cleaning

	⚠ DANGER
	Machine must be properly grounded to prevent electrical shock to personnel. DO NOT immerse in water. DO NOT clean appliance with a water jet. Always unplug the equipment before cleaning or servicing. <small>025_111616</small>

	⚠ WARNING
	To avoid burns, DO NOT touch heated surfaces. DO NOT place or leave objects in contact with heated surfaces. <small>009_092414</small>

Good sanitation practice demands that all food preparation equipment be cleaned regularly (only use non-toxic, food grade cleaners). A clean looking, well-kept machine is one of the best ways of advertising your product.

Cleaning Guidelines

1. Turn Power Switch OFF, unplug the unit, and allow it to cool before cleaning the unit.
2. Remove product bags and tubes.
3. Clean tray (slide tray out to remove it for cleaning).
4. Wipe interior and exterior surfaces of unit with a clean, slightly damp cloth. NEVER USE ABRASIVES on this unit.
Note: Periodically, use a vacuum cleaner and or a damp cloth to clean the air intake as needed.
5. Remove the pump head assemblies (by removing the thumb screw) and wipe clean; reattach the pump head assemblies.
6. Reinsert the clean, dry tray for use.





Troubleshooting

Issue	Possible Cause	Solution
Unit Not Working	A. Power to Unit	A. Make sure the unit is securely plugged into the wall outlet. Units with an IEC power cord, make sure cord is securely plugged into unit. Check the outlet for power. Check the circuit breaker for the wall outlet.
Door Will Not Close	A. Clamp Open B. Tray Not Fully Inserted	A. Close clamp. B. Install tray correctly.
Product Does Not Dispense	A. Product Empty	A. Replace empty bag.
Product is Leaking	A. Clamp Not Fully Closed B. Tube Loose from Spout	A. Close clamp. B. Check tube; be sure it is securely seated into bag (reference Product Installation section).
Tube Not Reaching Bottom of Clamp	A. Spout not seated correctly in Bag Support Tray	A. Seat the bag spout in the Bag Support Tray correctly (reference Product Installation section).
Product is Cold	A. Dispenser door left open; also see Power to Unit B. Pan Tray not in place	A. Keep door closed. B. Make sure pan tray is in place (reference Product Installation section).
Excess Product Remains in Bag	A. Bag spout not seated correctly in Bag Support Tray B. Folds in Bag	A. Seat the bag spout in the Bag Support Tray correctly (reference Product Installation section). B. Lay bag flat in tray.



MAINTENANCE INSTRUCTIONS

	⚠ DANGER
	<p>Machine must be properly grounded to prevent electrical shock to personnel. Failure to do so could result in serious injury, or death. DO NOT immerse any part of this equipment in water. DO NOT use excessive water when cleaning. Keep cord and plug off the ground and away from moisture. Always unplug the equipment before cleaning or servicing. Make sure all machine switches are in the OFF position before plugging the equipment into the receptacle.</p> <p>008_051514</p>

	⚠ DANGER
	<p>Improper installation, adjustment, alteration, service, or maintenance can cause property damage, injury, or death. Any alterations to this equipment will void the warranty and may cause a dangerous condition. This appliance is not intended to be operated by means of an external timer or separate remote-control system. NEVER make alterations to this equipment. Read the Installation, Operating, and Maintenance Instructions thoroughly before installing, servicing, or operating this equipment.</p> <p>014_020416</p>

	⚠ WARNING
	<p>No user serviceable parts inside. Refer servicing to qualified service personnel.</p> <p>011_051514</p>

	⚠ CAUTION
	<p>THE FOLLOWING SECTIONS OF THIS MANUAL ARE INTENDED ONLY FOR QUALIFIED SERVICE PERSONNEL WHO ARE FAMILIAR WITH ELECTRICAL EQUIPMENT. THESE ARE NOT INTENDED FOR THE OPERATOR.</p> <p>027_010914</p>



ORDERING SPARE PARTS

1. Identify the needed part by checking it against the photos, illustrations, and/or parts list. (General images may be used in manual for reference only.)
2. Use only approved replacement parts when servicing this unit.
3. When ordering, please include part number, part name, and quantity needed.
4. Please include your model number, serial number, and date of manufacture (located on the machine nameplate/data plate) with your order.
5. Address all parts orders to Parts Department, Gold Medal Products Co., 10700 Medallion Drive, Cincinnati, Ohio 45241-4807

or place orders by phone or online:

Phone: (800) 543-0862
(513) 769-7676

Fax: (800) 542-1496
(513) 769-8500

E-mail: info@gmpopcorn.com
Web Page: gmpopcorn.com



Cabinet Exterior – Decals and Bottom View



***CAUTION:** If supply cord is damaged, it must be replaced by Gold Medal Products Co., its service agent, or similarly qualified persons in order to avoid a hazard.

Item	Part Description	Part Number
		5301
1	TOP COVER PANEL	36090
2	LEFT PANEL DECAL	69002
3	RIGHT PANEL DECAL	69003
4	DOOR DECAL	69004
5	SWITCH	36038
6	BLACK EXTERIOR DOOR PANEL	36098
7	RUBBER BUMPER FOOT	87247
8	10-32 X 7/8 FLAT HD SCREW	69045
9	BASE PLATE	36080
10	STRAIN RELIEF SR-11-2 RA	87194
11	POWER CORD W/PCBA CONNECT	23038



Cabinet Front View - Interior

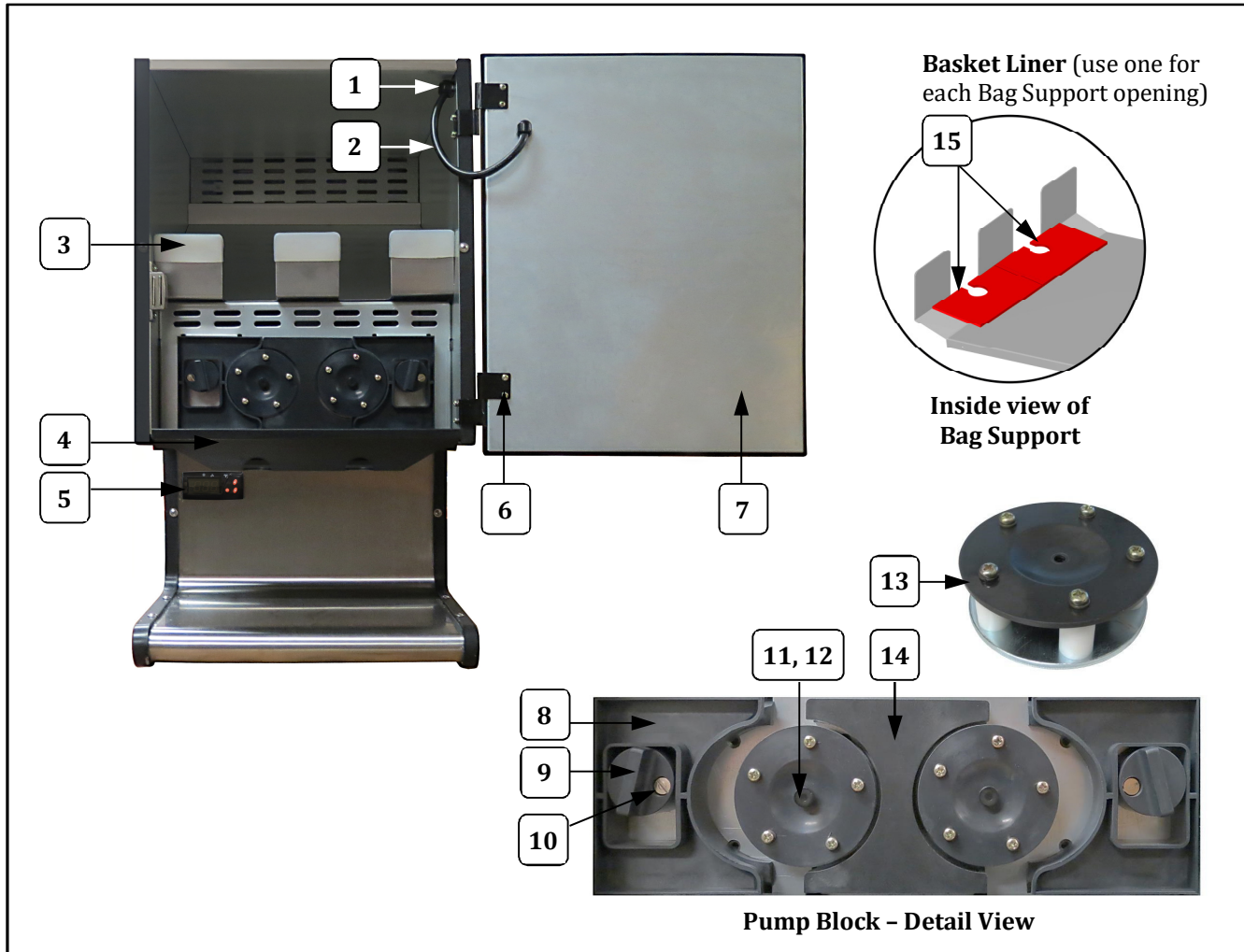

Item	Part Description	Part Number
		5301
1	STRAIN RELIEF SR-11-2 RA	87194
2	DOOR POWER CORD	37009
3	INTERIOR BAG SUPPORT	36085
4	BLACK SLIDE PAN (Tray)	36095
5	PROGRAMMED CONTROL	101120-010
6	HINGE KIT (contains both hinge sets)	69043
7	DOOR BASE PANEL SUPPORT	36097
8	SLIDING PUMP BLOCK	36031
9	PUMP CAM LOCK	36032
10	M5 SLOTTED SCREW	77125
11	PUMP MOUNT THUMB SCREW	77122
12	M3-WASHER-SPRING	77130
13	5 ROLLER PUMP HEAD ASSEMBLY	36105
14	BLACK PUMP CENTER	36100
15	BASKET LINER (1 liner)	100557



Cabinet Back View – Interior/Exterior

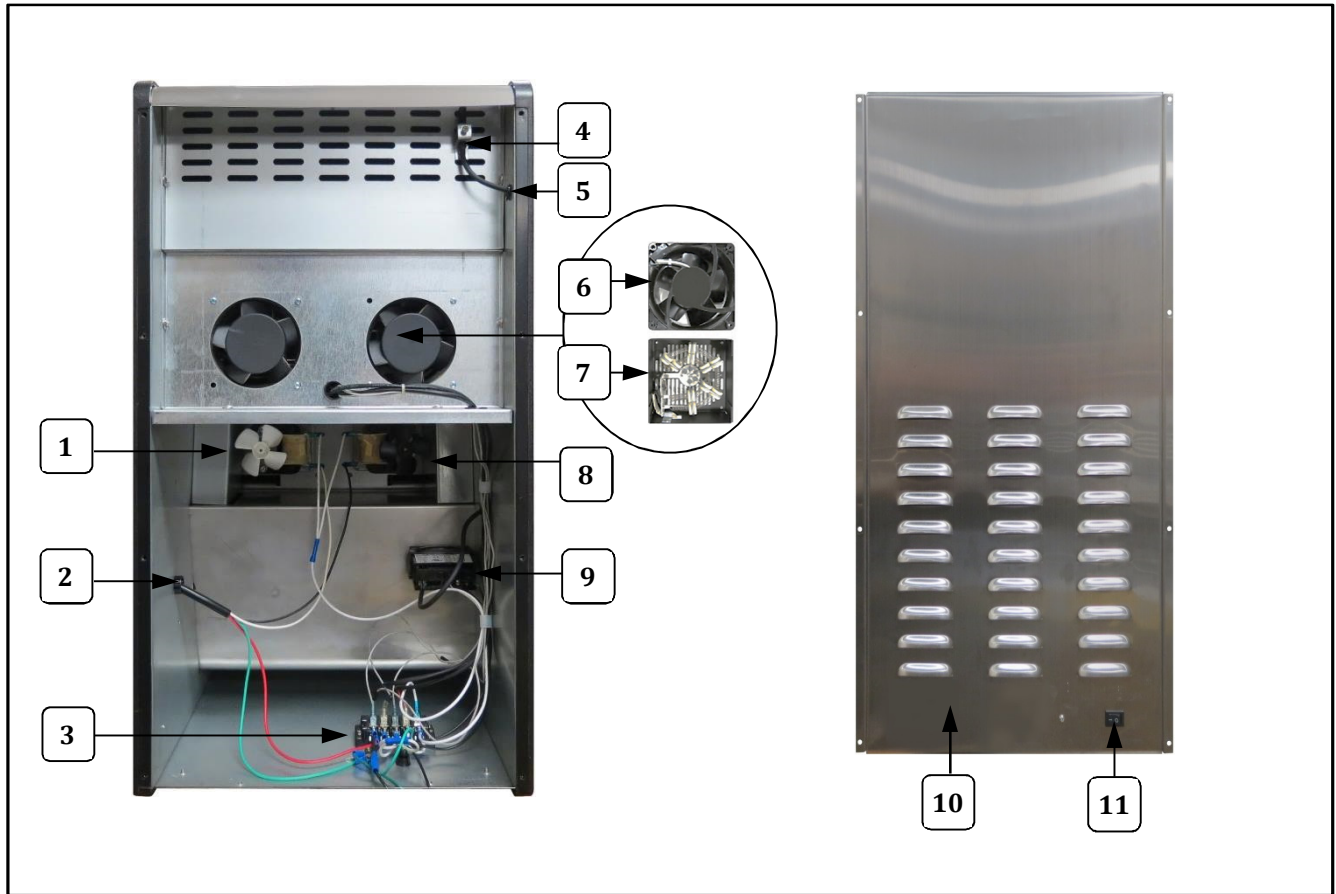

Item	Part Description	Part Number
		5301
1	MOTOR 120V SE ROT CW (White Fan)	36088R
2	.625" SNAP BUSHING	47282
3	TERMINAL BLOCK	69044
4	HEAT CONTROL SENSOR	36103
5	.500" SNAP BUSHING	47236
6	120 VOLT FAN	36075
7	HEATER ASSEMBLY SQ	36109
8	MOTOR 120V SE ROT CCW (Black Fan)	36088
9	PROGRAMMED CONTROL	101120-010
10	EXTERIOR REAR PANEL	36092
11	ROCKER SWITCH DPST	42532



Wiring Diagram

Model No. 5301

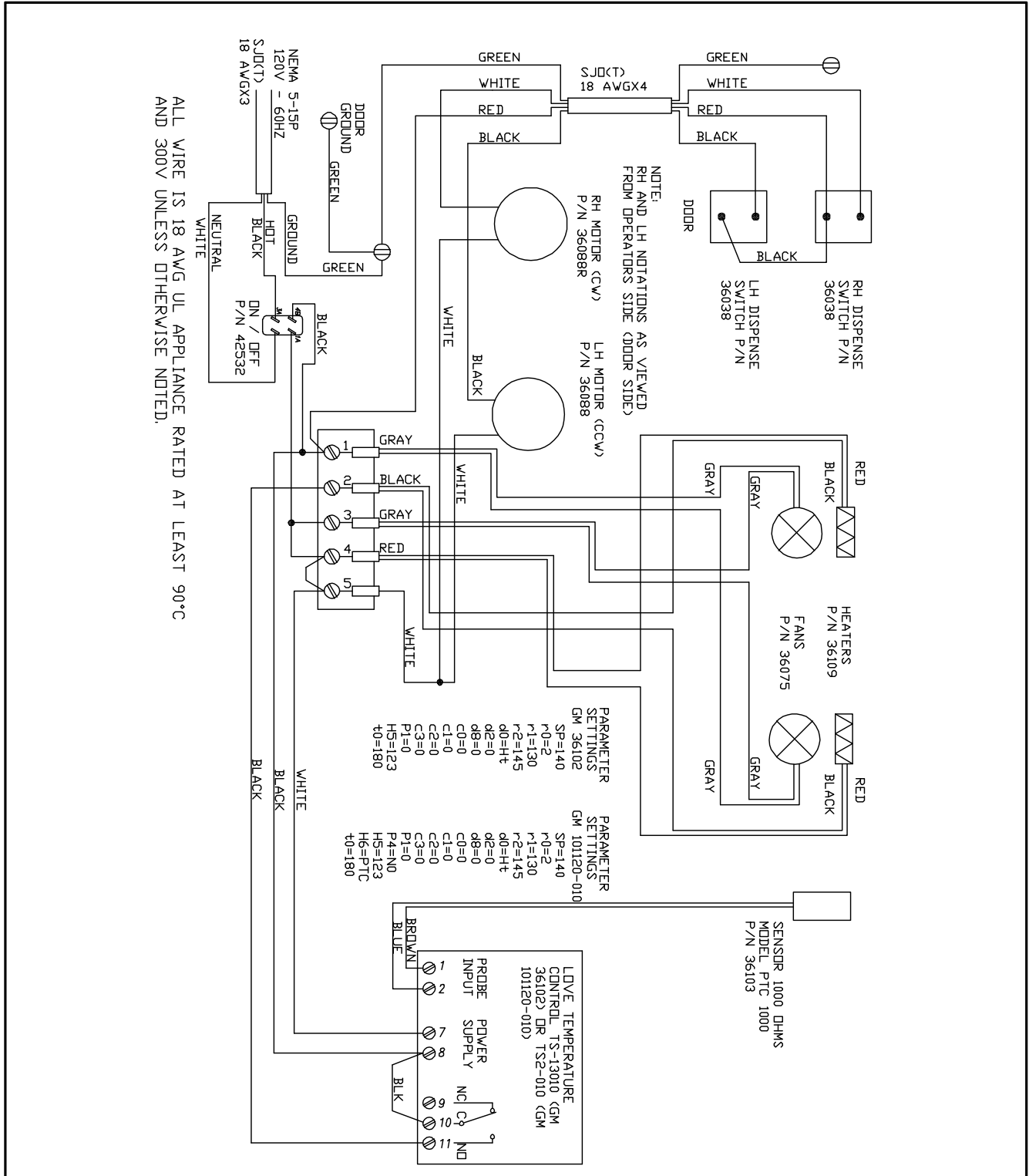

ALL WIRE IS 18 AWG UL APPLIANCE RATED AT LEAST 90°C AND 300V UNLESS OTHERWISE NOTED.



WARRANTY

Gold Medal Products Co. warrants to the original purchaser each item of its manufacture to be free of defects in workmanship and material under normal use and service. Gold Medal Products Co.'s obligation under this warranty is limited solely to repairing or replacing parts, f.o.b. Cincinnati, Ohio, which in its judgment are defective in workmanship or material and which are returned, freight prepaid, to its Cincinnati, Ohio factory or other designated point. Except for "Perishable Parts" on specific machines, the above warranty applies for a period of two (2) years from the date of original sale to the original purchaser of equipment when recommended operating instructions and maintenance procedures have been followed. These are packed with the machine. Parts warranty is two (2) years, labor is six (6) months.

THIS WARRANTY IS IN LIEU OF ALL OTHER WARRANTIES EXPRESSED OR IMPLIED, AND OF ALL OTHER OBLIGATIONS OR LIABILITIES ON OUR PART, INCLUDING THE IMPLIED WARRANTY OF MERCHANTABILITY. THERE ARE NO WARRANTIES WHICH EXTEND BEYOND THE DESCRIPTION ON THE FACE HEREOF. In no event shall Gold Medal Products Co. be liable for special, incidental or consequential damages. No claim under this warranty will be honored if the equipment covered has been misused, neglected, damaged in transit, or has been tampered with or changed in any way. No claim under this warranty shall be honored in the event that components in the unit at the time of the claim were not supplied or approved by Gold Medal Products Co. This warranty is effective only when electrical items have been properly attached to city utility lines only at proper voltages. This warranty is not transferable without the written consent of Gold Medal Products Co.

The term "Original Purchaser" as used in this warranty shall be deemed to mean that person, firm, association, or corporation who was billed by the GOLD MEDAL PRODUCTS CO., or their authorized distributor for the equipment.

THIS WARRANTY HAS NO EFFECT AND IS VOID UNLESS THE ORIGINAL PURCHASER FIRST CALLS GOLD MEDAL PRODUCTS CO. AT 1-800-543-0862 TO DISCUSS WITH OUR SERVICE REPRESENTATIVE THE EQUIPMENT PROBLEM, AND, IF NECESSARY, FOR INSTRUCTIONS CONCERNING THE REPAIR OR REPLACEMENT OF PARTS.

NOTE: This equipment is manufactured and sold for commercial use only.



GOLD MEDAL PRODUCTS CO.

10700 Medallion Drive, Cincinnati, Ohio 45241-4807 USA

gmpopcorn.com

Phone: (800) 543-0862 Fax: (800) 542-1496
(513) 769-7676 (513) 769-8500