

Model 100-EHBP Horizontal Diaper Changing Station with EZ Mount™ Backer Plate Installation Instructions



Thank you for purchasing a quality Foundations[®] product. Our goal is 100% consumer satisfaction! If, for any reason you are not satisfied or if you have questions regarding your product or installation, please contact our customer service team at 1-877-716-2757. Please **DO NOT** contact your distributor or reseller as we are better prepared to assist you.

WARNING

- Failure to follow these warnings and the installation instructions could result in serious injury or death.
- Read all instructions before installing diaper changing station. Keep these instructions. **DO NOT** discard.

ASSEMBLY INSTRUCTIONS

ADULT INSTALLATION REQUIRED.

TOOLS REQUIRED:

- Level (A)
- Measuring tape (B)
- Power drill with 7/32", 1/8" and 1/2" masonry bits (C)
- Power screwdriver with bull nose phillips bit (D)

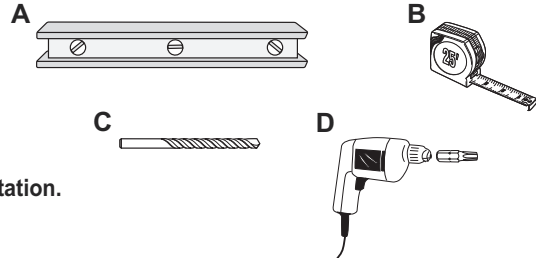

- READ ALL INSTRUCTIONS BEFORE ASSEMBLY OF Diaper Changing Station.
- Unpack carton and identify all parts.

IMPORTANT NOTE:

The EZ Mount™ Backer Plate may or may not be included with the model you purchased. The backer plate is intended to reduce installation time and costs as well ensure connection to two studs. Safe installation can also be achieved without the use of the backer late by following the instructions provided.

If your model did not include an EZ Mount™ Backer Plate and you have determined that you would like to purchase one, please contact us at 1-877-716-2757 if you have any questions. The part number is A100-BPEH.

PARTS LIST

Parts Description	Quantity
Hardware for installation:	
3" Wood Screws	4
3/4" Finishing Washers	4
3" Machine Screws	2
3/4" Flat Washers	4
Toggle Anchors	2
1-1/4" Caps	6
Door / Wall Plate	1

For Wood Studs:



For Use With Toggle Anchors:

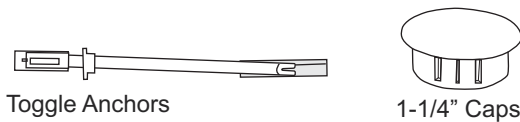

Door / wall plate to be mounted on outside of restroom door.



A.D.A. Compliance:



- 4.4.1 Maximum Protruding Objects
 - 4.2.5 Forward Reach
 - 4.2.6 Parallel Approach
 - 4.27.4 Operation
- Compliant when properly installed.

Distributed by
www.Ameraproducts.com
 Phone: (800) 608-6568
 Fax: (409) 840-5545
info@ameraproducts.com

⚠ WARNING

- A stud **MUST** be located and used for at least one side of the diaper changing station.
- The diaper changing station is no stronger than the anchors or walls to which they are attached and, therefore, **MUST** be firmly secured in order to support the weight they are intended to support. Contact an architect or building contractor if any questions.

INSTALLATION

NOTE: If using a backer plate, go to “Using Backer Plate Mounting System” section.

1. Locate wood stud where left side of changing station will be mounted to the wall.
2. Measure up 46” (117 cm) from the floor and mark the wall. This locates the position for the top left attachment hole.
NOTE: Mark on wall **MUST** be in center of wood stud.
3. Align hole in top left corner of changing station with mark on wall and hold in place.
4. Using a level and measuring tape, mark the remaining three (3) holes. After marking holes, set changing station down on ground.
5. Use a power drill and appropriate bit to drill four (4) holes in the wall. This may require 2 people.

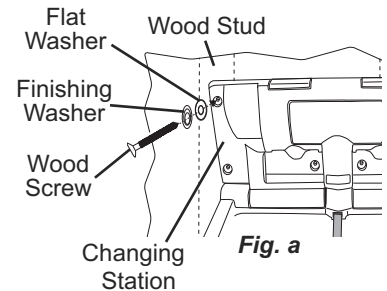

NOTE 1: For wood studs:

- If finished wall surface is tile or masonry over wood studs, use a 7/32” masonry bit for the pilot hole until you hit the wood stud, then change to 1/8” bit.
- Use wood screws, finishing washers and flat washers (**Fig. a**).

NOTE 2: For use with toggle anchors:

- If finished wall surface has wood studs that are not 16” on center, has metal studs, or has an underlying surface of concrete block, use 1/2” bit.
- Use machine screws and flat washers (**Fig. b**).
- For holes **NOT** located in a wood stud, toggle anchors **MUST** be used (**Fig. c**). See “Using Toggle Anchors” section.

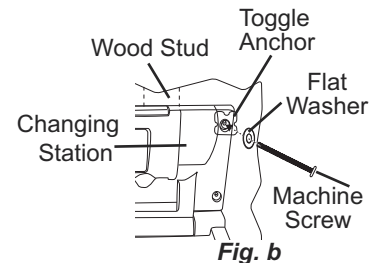

6. Align holes in changing station with drilled holes and secure top left corner of changing station to wall stud using the appropriate screw and washer. Continue to secure the three (3) remaining corners using the appropriate screws and washers as described in **Note 1** or **Note 2**.

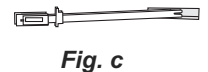

⚠ WARNING

- All 4 of these locations **MUST** be used for safe installation. The lower holes ensure installation through the metal brackets.



7. Ensure all four (4) screws are tight and snap caps over screw heads.

Using Toggle Anchors:

1. Insert metal end of toggle anchor into 1/2” hole.
2. Slide zip strip down snugly against wall.
3. Snap off break-away pieces of toggle anchor (**Fig. d**).
4. Align holes in changing station with toggle anchors and secure top left corner of changing station to wall using machine screws and flat washers. Continue to secure the three (3) remaining corners using machine screws and flat washers.
5. Ensure all four (4) screws are tight and snap caps over screw heads.

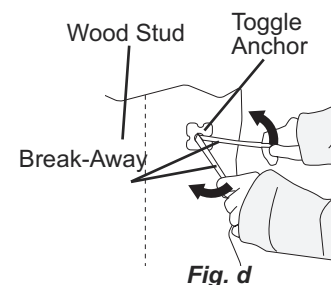

RECOMMENDED BLOCKING:

If the walls do not have studs on center, then additional blocking is necessary (*Fig. e*).

Contact an architect or building contractor to make sure the blocking is adequate and complies with building codes.

OPERATION:

Rotate base downward. Place infant on top of the changing surface. Use restraint system as described below. After child has been changed, remove restraint system and rotate base back up against the wall.

USE OF RESTRAINT SYSTEM:

Place child so restraint strap is located at abdomen. Rotate top of buckle upward and insert strap in buckle. Pull strap through buckle until snug against infant. Rotate top of buckle downward to lock the strap into place. Slide red locking tab over top of buckle (*Fig.f*). Reverse steps to loosen strap.

MAINTENANCE AND CLEANING:

Check all hardware and components monthly or as required to ensure hardware is tight and there are no missing or damaged components. Take unit out of service if any component is missing or damaged and contact customer service to order replacement parts. Do not substitute parts. For replacement parts, contact customer service at 1-877-716-2757.

Clean by using a damp cloth with mild soap or mild multi-purpose cleaner. Do not use any strong chemical cleaners or cleaning agents that may be hazardous to children.

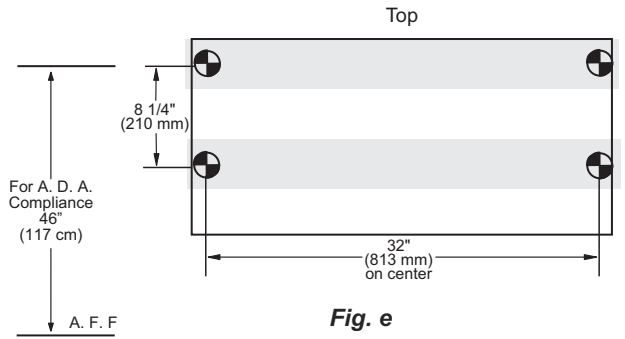

Fig. e

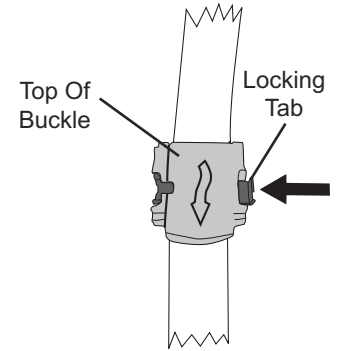

Fig. f

⚠ WARNING

- Child should never be left unattended.
- Avoid serious injury from falling or sliding out. Always use restraint system.
- Adding excessive weight such as parcels, packages, or accessories to the unit or to the bag hooks that exceed the total weight limit of 50 pounds (22.7 kg) may cause the unit to be unstable or may cause a hazardous unstable condition to exist.

Using Backer Plate Mounting System:

If your changing station was supplied with a backer plate, please follow these instructions. If a backer plate was not supplied and you would like to order one, see information on page 1.

The backer plate is designed to enhance the attachment method to ensure that at least one wood stud is used to support the changing station.

⚠ WARNING

- A stud **MUST** be located and used for at least one side of the diaper changing station.
- The diaper changing station is no stronger than the anchors or walls to which they are attached and, therefore, **MUST** be firmly secured in order to support the weight they are intended to support. Contact an architect or building contractor if any questions.
- Use backer plate mounting system with at least four (4) standard mounting screws. The backer plate alone is **NOT** a secure attachment method.

1. Locate wood stud where left side of changing station will be mounted to the wall.
2. Measure up 46" (117 cm) from the floor and mark the wall.
NOTE: Mark on wall **MUST** be in center of wood stud.
3. Using two (2) 3" wood screws and a level, mount the backer plate to the center of the wood stud (*Fig. g*).
NOTE: The lip of the backer plate **MUST** be facing away from the wall (*Fig. h*).

Repeat steps to secure backer plate to another stud on the opposite side.

4. Slide recessed area on back of changing station onto lip of backer plate.
5. Return to installation step 5.

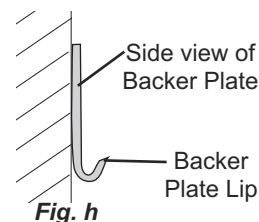

Fig. h

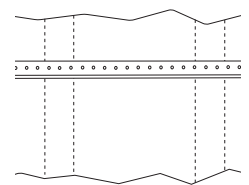

Fig. g