

# Quartz Tube Patio Heater

## ASSEMBLY AND OPERATION INSTRUCTIONS



### WARNING

- Read these instructions before using this appliance. The appliance must be installed in accordance with the instructions and local regulations. The use of this appliance in enclosed areas can be dangerous and is PROHIBITED.
- Do the leak test after each changing of LPG cylinder.
- Never check for leaks with a match or open flame.
- Do not store or use gasoline or other flammable vapors and liquids in the vicinity of this appliance.

### IF YOU SMELL GAS

- Close the valve of the gas cylinder or regulator.
- Extinguish all naked flames; do not operate any electrical appliances.
- Check for leaks as detailed in these instructions.
- If odor persists, contact AZ Patio Heaters at 1-888-775-1330.



DO NOT RETURN THIS ITEM TO STORE WHERE PURCHASED. PLEASE CALL **1-888-775-1330 (ENGLISH ONLY)** WITH QUESTIONS OR WARRANTY ISSUES MONDAY TO FRIDAY 8:00 a.m. - 4:30 p.m. SATURDAY/SUNDAY 8:00 a.m - 2:00 p.m PST OR VISIT OUR WEBSITE **[WWW.AZPATIOHEATERS.COM](http://WWW.AZPATIOHEATERS.COM)**.

FOR OUTDOOR USE ONLY.  
KEEP THESE INSTRUCTIONS FOR FUTURE REFERENCE.

## PRECAUTIONS

- Installation and services should only be made by a qualified person.
- Do not use the heater in an explosive atmosphere.
- Before operation, inspect the hose for damage.
- Disconnect LPG cylinder before moving the heater.
- Do not attempt to alter any parts of the heater.  
Example: Using the heater without reflector or protection guard.
- The appliance shall not be used in basements or below ground level.
- It must always be placed on a solid and level surface.
- Never substitute the regulator. Use only one that is suitable for both appliance category and normal pressure of gas.
- Do not clean the heater with cleaners that are combustible or corrosive.
- Do not paint protection guard, control box or reflector.
- The LPG gas cylinder valve should be turned off when the heater is not in use.
- Do not use the heater when it is raining, and do not let any liquid splash on to the glass tube when the heater is in use.
- Keep children away from the heater, always be careful not to knock over the heater which will break the glass tube and might cause injury.
- Do not move the appliance when in operation.
- After a long break in operation, the gas parts in the control box of the heater and the hose should be inspected for spiders, spider webs or other insects.
- Check the heater immediately if any of the following exists:
  1. There is smell of gas.
  2. The heater is not effective enough.
  3. The burner makes popping noise during use (a slight popping noise is normal when the burner is extinguished after use).
- If you smell gas, turn off the valve immediately. If smell persists, contact the AZ Patio Heaters at 1-888-775-1330.
- The hose with regulator assembly should be stored in a safe place to avoid accidental damage.
- Children and adults should be aware of the high surface temperature hazard, and should keep a safe distance away to avoid clothes burning or igniting.







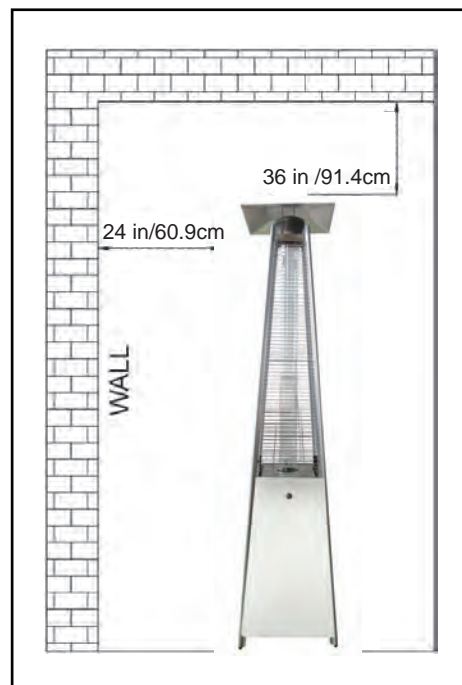





- Young children should be carefully supervised when they are in the working area of the heater.
- Clothing or other flammable material should not be hung from the heater, or placed on or near the heater.
- Do not obstruct the flow of combustion products.
- Keep the ventilation opening of the cylinder enclosure free and clear of debris.
- Do not obstruct the ventilation holes of the cylinder housing.
- Shut off the valve to the gas cylinder or the regulator before moving the appliance.
- The tubing or the flexibel hose must be changed within the prescribed intervals.
- Use only the type of gas and the type of cylinder specified by the manufacturer.
- In case of violent wind, particular attention must be taken against tilting or falling over of the appliance. The manufacturer is not responsible for any damaged caused by bad weather.

## APPLIANCE STAND AND LOCATION

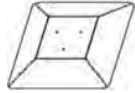
- The appliance is for outdoor use only. Do not use indoors or in an enclosed area.
- Always maintain adequate clearance from combustible materials, i.e. top 36 in /91.4cm and sides 24 in /60.9 cm.

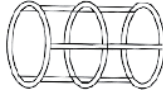

# PARTS LIST

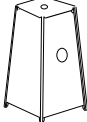
PART NUMBER	PART NAME	PICTURE	QUANTITY	DESCRIPTION
A	TWO SIDED BOLTS WITH WING NUTS		3	CONNECTS REFLECTOR TO THE FLAME SCREEN
B	M3/16 SCREWS		36	STANDARD SCREWS TO ASSEMBLE FLAME HEATER
C	KNOB WITH CHAIN		1	ATTACH TO THE FRONT PANEL
D	GUARD FASTENING PIECES		4	FASTENING PIECE TO KEEP THE GUARD FIRMLY IN PLACE
E	GUARD CONNECTOR		8	CONNECTS THE TWO PARTS OF THE WIRE GUARD TOGETHER
F	WHEEL KIT WITH HARDWARE		1	MOUNTS TO BASE
G	REFLECTOR		1	
H	STABILITY RING		1	ATTACH TO BASE
AA	FLAME SCREEN		1	
BB	MESH GUARD		4 SETS	
CC	ALUMINUM TUBES		4 SETS	
DD	RING		1	
EE	GLASS TUBE		1 SET	
FF	RUBBER RING		1	
GG	TANK HOUSING ASSEMBLY		1	

Please call us at 1-888-775-1330 (English only) for missing parts.

## EXPLODED VIEW

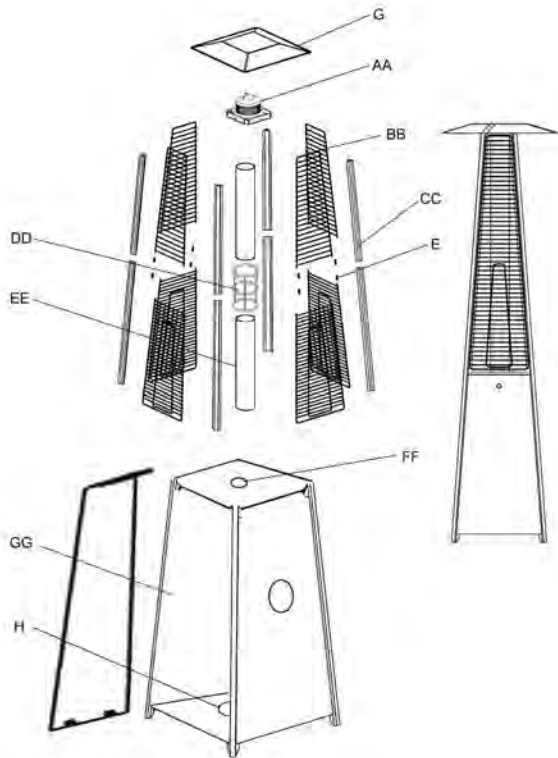

Please call us at 1-888-775-1330 (English only) for missing parts.

## LEAKAGE TEST

Gas connections on the appliance are leak tested at the factory prior to shipment. Possible mishandling of the appliance during the shipment process might contribute to product integrity as a whole. A complete gas leakage test must be performed again at the installation site. Please follow the procedure below for leakage test.

- Make a soap solution of one part liquid detergent and one part water. The soap solution can be applied with spray bottle, brush or rag. Soap bubbles will appear where a leak is present.
- Make sure the control knob is in the "OFF" position (full disk = ●) on the control panel.
- Turn on the gas supply and check for bubbles from the hoses and connections. Presence of bubbles means that a leak path is present.
- If a leak is present, turn OFF the gas supply immediately, tighten any leaking fittings carefully, turn gas on again and recheck.
- Never leak test while smoking, or near an open flame.

## INSTALLATION

Important safety requirements:

**THIS APPLIANCE IS FOR OUTDOOR USE ONLY**

1. This appliance shall not be installed or used indoors, in buildings, garages or any other enclosed area.
2. DO NOT place articles on or against this appliance.
3. DO NOT use or store flammable materials near this appliance.
4. DO NOT operate this appliance unless it is fully assembled with reflector and protection guards in place.
5. Installation and repair should be done by a qualified service person. The appliance must be inspected before use and at least annually by a qualified service person. More frequent cleaning may be required as necessary. It is imperative that the control compartment, burners and circulating air passages of the heater and light be kept clean.

## HEATER ASSEMBLY

**STEP 1:** (PART GG) Open the front panel and take out all of the parts.



**STEP 2:** Open the wheel box, disassemble the screws. Attach the wheels (PART F) on the brackets and tighten the nuts and bolts to the base. Make sure the wheel mounting is angled upwards and the wheels sit flush with the ground.



**STEP 3:** Mount the stability ring(PART H) to the base of the heater.

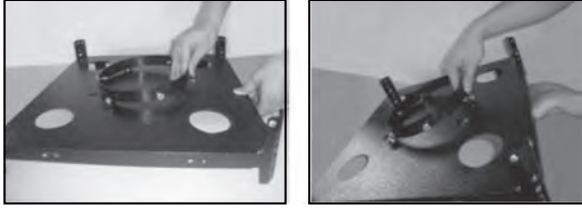

**STEP 4:** Open the aluminium tube carton, take out all of the aluminium tubes (PART CC) Connect two tubes together. Screw the bolts in the middle position tightly using the hardware provided (PART B 8PCS).

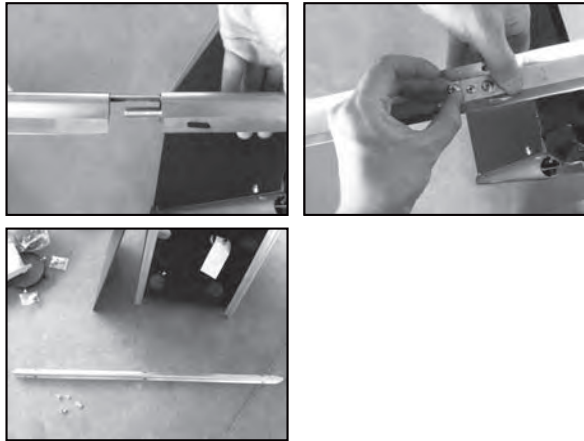

**STEP 5:** Install 4 pieces of connected tube on the top of the pre-assembled base(PART GG). Screw the bolts at the bottom tightly. (PART B 16PCS)

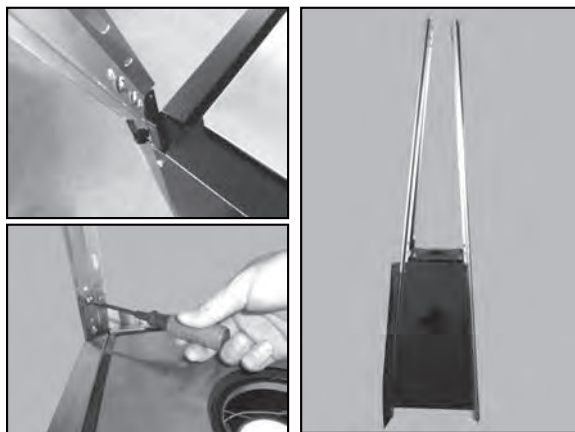

**STEP 6:** Open the flame screen carton, take out the flame screen (PART AA) to the top of the aluminium tubes using hardware provided (PART B 8PCS)



**STEP 7:** Take out 3 two sided bolts (Part A) out of screw pack, and connect to flame screen(Part AA). Attach reflector(Part G) through the 3 bolts. Then tighten the shield with the 3 wing nuts.

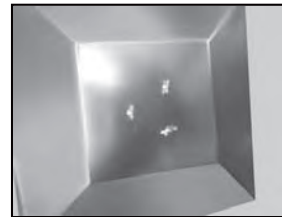
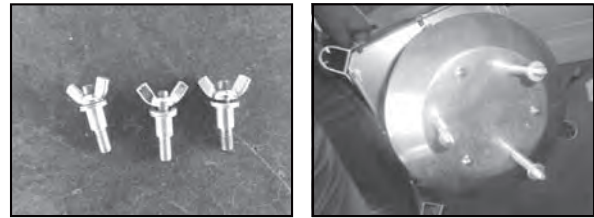

**STEP 8:** Open the glass tube box and take out the glass tube (PART EE). Squeeze the stainless steel ring together(PART DD), and carefully slide the ring inside one end of the glass tube( PART EE).

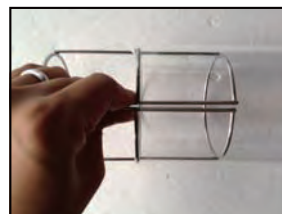
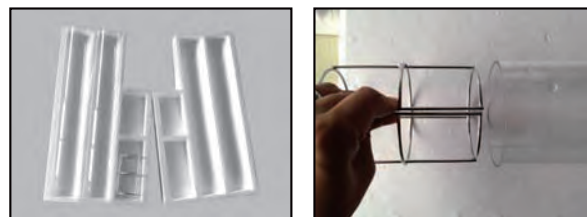

**STEP 8.1:** Slide the other side of stainless steel ring (PART DD) into the second glass tube(PART EE) by squeezing the stainless steel ring together( PART DD).

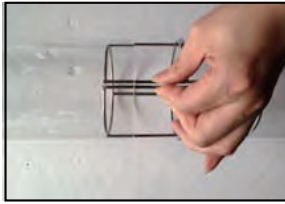

**STEP 8.2:** Insert the assembled glass tubes into the heater by holding the base in one hand, top in the other, and insert the tube underneath the flame screen (PART AA).

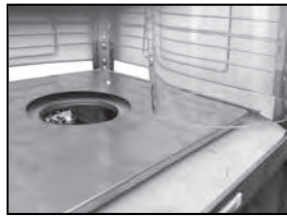

**STEP 8.3:** After inserting one side into the flame screen (PART AA), place the lower end on the rubber ring (PART DD) on top of the ceramic burner.



**STEP 8.4:** Before inserting the assembled tube, please make sure the tubes are fully connected. A bad connection may cause damage to the glass tubes.

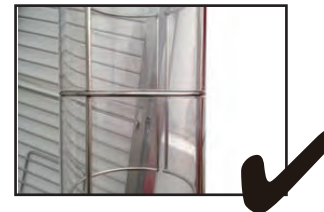

### CAUTION

Make sure two glass tubes are tightly connected. After assembling, the total length should be 49.5 in/125.7cm. Avoid scratching the interior surfaces of tubes with the stainless steel ring while joining the tubes.

**STEP 9:** Open the mesh guard carton, take out mesh guard(Part BB). Hang the screens on the four sides of aluminium tubes(Part U) and connect top parts and bottom parts with small steel connector tubes(Part E) from glass tube box.

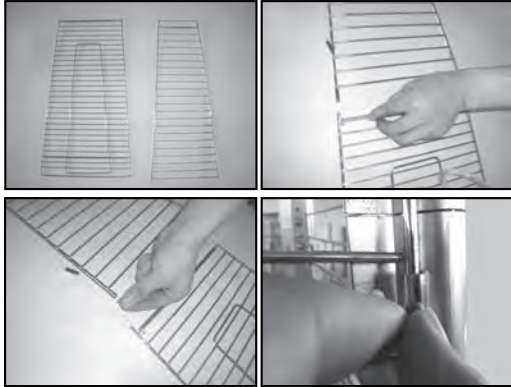

**STEP 10 :** Take guard fastening pieces from glass tube box. Screw the guard fastening pieces(PART D) on the top of the mounting plate to keep the screen firmly in place. (PARTB-4PCS )

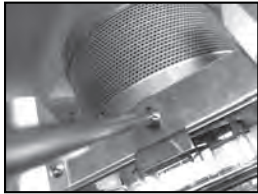

**STEP 11 :** Screw the knob with the chain (PART C) into the front panel and attach chain to the control box.



Installation process is complete. Please remove protective membrane off stainless steel before you use.



## OPERATION

### Preparation:

You will need to purchase a LPG cylinder. You need a suitable size LPG cylinder(20lb Tank) that will be installed in the housing.

You have to use the pressure regulator with an outlet pressure in compliance with the appliance category. The flexible tube must be approved also.

Connect the hose to the hose connector in the control box

### Warning:

Always test the hose for leaks with soapy water at both of the connections.

### Warning:

- Never use the heater while it is raining, the glass tube can break when it is suddenly met with water.

- Always turn off the heater while it is raining.

- Never splash any liquid on to the glass tube when the heater is working.

- The glass tube will be extremely hot when it is working, never try to touch it and keep children away from the heater.

- Always ensure the heater stands firm. The glass tube may break if the heater falls over.

- Never use the heater if the glass tube has any cracks.

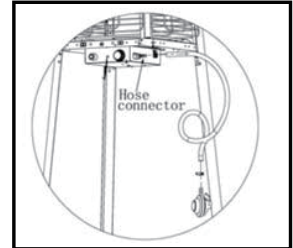

### LIGHTING INSTRUCTIONS

1. Check and ensure a AA battery (included) is inside the ignition chamber and has power. Ensure the anode(+) faces outside.

2. Ensure the control knob is OFF,slowly open the gas cylinder valve.

3. Press and turn the control knob to PILOT position and hold in for 1 full minutes.

4. Push the igniter to generate spark while keeping control knob in depressed position.

5. Check for pilot

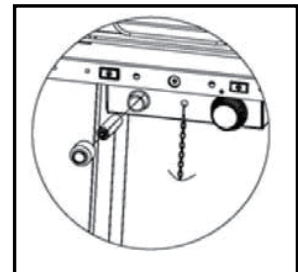

flame through glass tube. If pilot does not light, turn control knob to 'OFF' position wait two minutes minimum and try again from step 2. Several attempts may be necessary.

5. If the pilot lights, keep control knob pressed for 30 seconds longer then turn the control knob to 'LOW'.

6. For maximum heat turn control knob to 'HIGH'.

7. To turn heater off, turn control knob to 'OFF'.

8. Close the valve of the gas cylinder or the regulator after use.

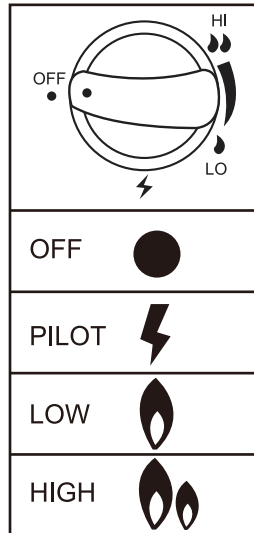

## CLEANING/MAINTENANCE/STORAGE

### CLEANING AND MAINTENANCE:

- To enjoy outstanding performance of your heater for years, make sure to perform the following maintenance activities on a regular basis:
  - Keep exterior surfaces clean.
  - Use warm soapy water for cleaning. Never use flammable, corrosive or abrasive cleaners.
  - While washing your unit, be sure to keep the area around the burner and pilot assembly dry at all time. If the gas control is exposed to water in any way, do NOT try to use it. It must be replaced.
  - After a long break from operation, the unit should be inspected for spiders, spider webs or other insects.
  - Air flow must be unobstructed. Keep controls, burner, and circulating air passageways clean. Signs of possible blockage include:
    - Heater does NOT reach the desired temperature
    - Heater makes popping noises.
    - Spiders and insects can nest in burner or orifices.
 This dangerous condition can damage heater and render it unsafe for use. Clean burner holes by using a heavy-duty pipe cleaner. Compressed air may help clear away smaller particles.
    - Carbon deposits may create a fire hazard.
 Clean reflector and glass tube inside with soapy water if any carbon deposits develop. Always be careful when cleaning the glass tube.

### STORAGE:

#### Between uses:

- Turn the control knob to "OFF" position.
- Turn LPG cylinder to "OFF" position.
- Store heater upright in an area sheltered away from weather conditions (such as rain, sleet, hail, snow and wind).
- If desired, cover heater to protect exterior surfaces and to help prevent dust and debris collecting in air passages.

#### During periods of extended inactivity or when transporting:

- Turn the control knob to "OFF" position.
  - Disconnect LPG Cylinder and move to a secure well-ventilated location outdoors.
- DO NOT store in a location that will exceed 120 degrees F/48.8 Celsius.**
- Store heater upright in an area sheltered away from weather conditions (such as rain, sleet, hail, snow and wind).
  - If desired, cover heater to protect exterior surfaces and to help prevent dust and debris collecting in air passages.

## WARNING

### FOR YOUR SAFETY:

- DO NOT touch or move heater for at Least 45 minutes after use.
- Allow all burner elements to cool before touching.

## NOTE

- In a salt-air environment (such as near an Ocean) corrosion occurs more quickly than normal.
- Frequently check for corroded areas and repair them promptly.
- Wait until heater is cool before covering.



## Technical Specifications

ITM. / ART.639564  
 PH08-SSB / HLDS01-GTSS  
 Input rate: 40000BTU/HR-11.7KW/HR  
 Gas: Propane  
 Gas supply pressure: 25 to 250PSI / 3.5-10.5Kg/cm<sup>2</sup>  
 Manifold pressure: 11"WC-2.74KPA  
 INJECTOR SIZE: 1.95mm-0.07 in



## Troubleshooting

PROBLEM	PROBABLE CAUSE	SOLUTION
Pilot will not light	Gas valve may be OFF	Turn the gas valve ON
	LPG cylinder empty	Refill LPG cylinder
	Orifice blocked	Clean or replace Orifice
	Air in supply system	Purge air from lines
	Loose connection	Check all fittings
Pilot will not stay on	Debris around pilot	Clean dirty area
	Loose connection	Tighten connection
	Thermocouple bad	Replace Thermocouple
	Gas leak in line	Check connections
	Lack of gas pressure	LPG cylinder is near empty
Burner will not light	Gas pressure is low	LPG cylinder is near empty
	Orifice blocked	Remove, clean and replace
	Control knob not ON	Turn knob to ON
	Thermocouple bad	Replace Thermocouple
	Pilot light assembly bent or not in correct location.	Place pilot light in correct position and retry.

Any repairs to the patio heater must be carried out by a qualified person. For further assistance, contact AZ Patio Heaters at 1-888-775-1330 (English only).

MADE IN CHINA

Distributed by  
 AZ Patio Heaters LLC  
 8550 N. 91st Ave  
 Suite C-25 Peoria, AZ 85345  
 1-888-775-1330  
 WWW.AZPATIOHEATERS.COM  
 Warranty@azpatioheaters.com