



## STANDARD FEATURES

### ⌘ DURABLE STAINLESS STEEL

Our reach-ins boast a sturdy stainless steel exterior and interior finish and galvanized back panel providing strength and durability.

### ⌘ ERGONOMICALLY DESIGNED DOORS WITH LOCKS

Standard solid and glass doors come with easy grip handles and self closing/90 ° stay open door feature, working together for customer convenience.

### ⌘ MAGNETIC DOOR GASKET

Built of one piece, the gasket is removable without tools for ease of cleaning and replacement. Door's in step design gives added protection to the gasket.

### ⌘ DIGITAL CONTROLLER

This temperature control system on refrigerators and freezers allows customers to keep the utmost food quality for a longer period of time.

### ⌘ HIGH DENSITY POLYURETHANE INSULATION

2-3/8" Ecomate® CFC-Free polyurethane insulation foamed in place including the mullion on double doors for extra strength and energy efficiency, while being environmentally friendly with zero ozone depletion potential (ODP) and zero global warming potential (GWP).

### ⌘ EFFICIENT REFRIGERATION SYSTEM

Factory engineered oversized and balanced refrigeration system. CFC-free R-134A Refrigerators maintain temperature from 33° to 38°F, 3 door refrigerator is R-404A.

R-404A Freezers maintain temperature at -10°F, for single door, double and triple door -8°F.

### ⌘ BOTTOM MOUNT COMPRESSOR

Allows easier access with service friendly rails while adding more storage space above. This system provides a cool and clean operating environment enhancing the compressor life.

### ⌘ ALL BASIC PAN SIZES ACCEPTED, including 18" x 26".

### ⌘ DUAL PANE GLASS DOORS

"G" model units come with dual pane glass doors with aluminium frames and LED interior lights for better operation and efficiency.

### ⌘ INCANDESCENT LIGHT & SWIVEL CASTERS

Solid door units come with interior incandescent and all units have 4"

## OPTIONS & ACCESSORIES

Additional epoxy coated shelves / 2.5" Casters / 6" Adjustable stainless steel legs / Factory reverse door hinging / 220V-50 cycles- 1 phase

# Reach-ins REFRIGERATORS & FREEZERS

- ❑ ARR-23
- ❑ ARR-23-1G
- ❑ ARF-23
- ❑ ARR-49
- ❑ ARR-49-2G
- ❑ ARF-49
- ❑ ARR-72
- ❑ ARR-72-3G
- ❑ ARF-72



ARR-(F) 23



ARR-(F) 49



ARR-(F) 72



MODEL	DOORS	CAPACITY (Cu.Ft)	SHLVs.	AMPS	HP	VOLTAGE	NEMA PLUG	CORD LENGTH	CABINET DIMENSIONS			SHIPPING	
									L	D	H*	WT.	CUBES
<b>REFRIGERATOR</b>													
ARR-23	1	23	3	5.6	1/4	115	5-15P	8'	27-1/2"	31"	79-1/2"	301	51
ARR-49	2	49	6	6.9	1/3	115	5-15P	8'	55-1/2"	31"	79-1/2"	475	95
ARR-72	3	72	9	12.7	3/4	115	5-20P	8'	83-1/4"	31"	79-1/2"	665	155
ARR-23-1G	1	23	3	6.0	1/4	115	5-15P	8'	27-1/2"	31"	79-1/2"	315	51
ARR-49-2G	2	49	6	7.3	1/3	115	5-15P	8'	55-1/2"	31"	79-1/2"	515	95
ARR-72-3G	3	72	9	12.7	3/4	115	5-15P	8'	83-1/4"	31"	79-1/2"	705	155
<b>FREEZER</b>													
ARF-23	1	23	3	8.5	3/4	115	5-15P	8'	27-1/2"	31"	79-1/2"	325	51
ARF-49	2	49	6	12.9	1	115	5-15P	8'	55-1/2"	31"	79-1/2"	500	95
ARF-72	3	72	9	14.5	1	115	5-20P	8'	83-1/4"	31"	79-1/2"	685	155

\*Height does not include 5" overall for casters



ARR-23 View

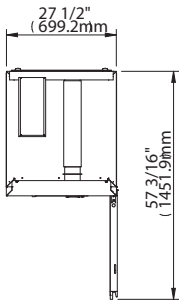

ARR-49 View

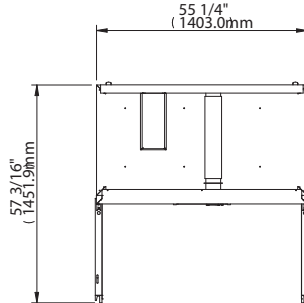

ARR-72 View

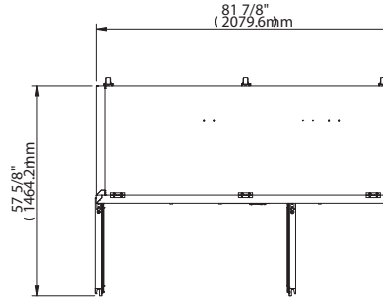

Top View

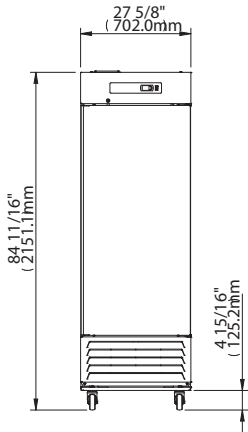

Top View

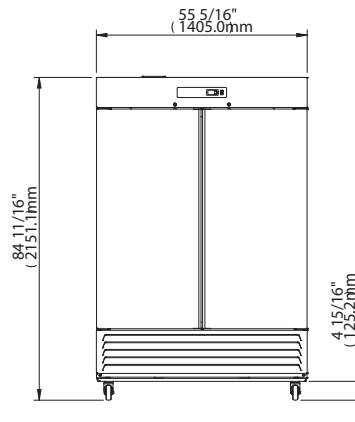

Top View

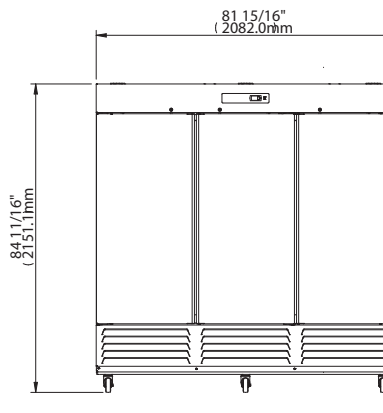

Common View

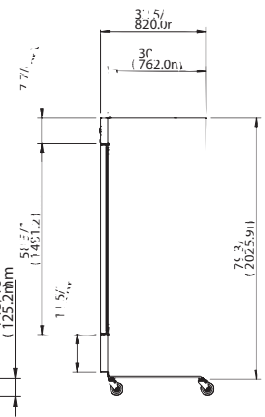

## \* Specifications

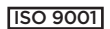

### ④ CABINET CONSTRUCTION

- EXTERIOR: Stainless steel, galvanized steel back.
- INTERIOR: Stainless steel.
- CABINET & DOOR : entire foamed-in-place high-density, CFC-free, polyurethane insulation. Covered corner floor to meet NSF requirements.
- CASTERS: 4" Diameter swivel casters, front with brakes.
- SHELVES: 3 Adjustable epoxy coated wire shelves per door.

### ④ DOORS

- Solid doors have stainless steel front and interior. "G" glass door models are dual pane with aluminium frame.
- Doors in step design gives added protection to the gasket.
- GASKETS: One piece construction magnetic gasket, removable without tools for easy cleaning.
- CLOSING SYSTEM: Self-closing doors with 90° stay open feature for convenient loading and unloading.

### ④ REFRIGERATION SYSTEM

- Oversized and balanced refrigeration system.
- R-134A holding temperature at 33°F to 38°F Refrigerators. R-404A for 3 door Refrigerator.
- R-404A holding temperature at -10°F Freezers for single doors and -8°F on double and triple doors.
- Self-contained capillary tube system using environmentally friendly refrigerant Ecomate® (CFC free).

- Bottom mount compressor with service friendly rail system.
- Evaporator coil is mounted in the rear of the unit with full accessibility from the back.
- Large fan motor and fan blades for better air circulation.
- Self contained system, no plumbing necessary.

### ④ ELECTRICAL

- The whole unit is completely pre-wired at factory with cord and plug set included and ready for final connection to a 115/60/1 phase.
- 220V/50 Hz/ 1 Ph available from factory.

### ④ WARRANTY

Continental USA & Canada:

- **One year** labor and parts warranty.
- **Five year** compressor warranty.
- **International:** one year parts only.